

1. Main

Exploded View

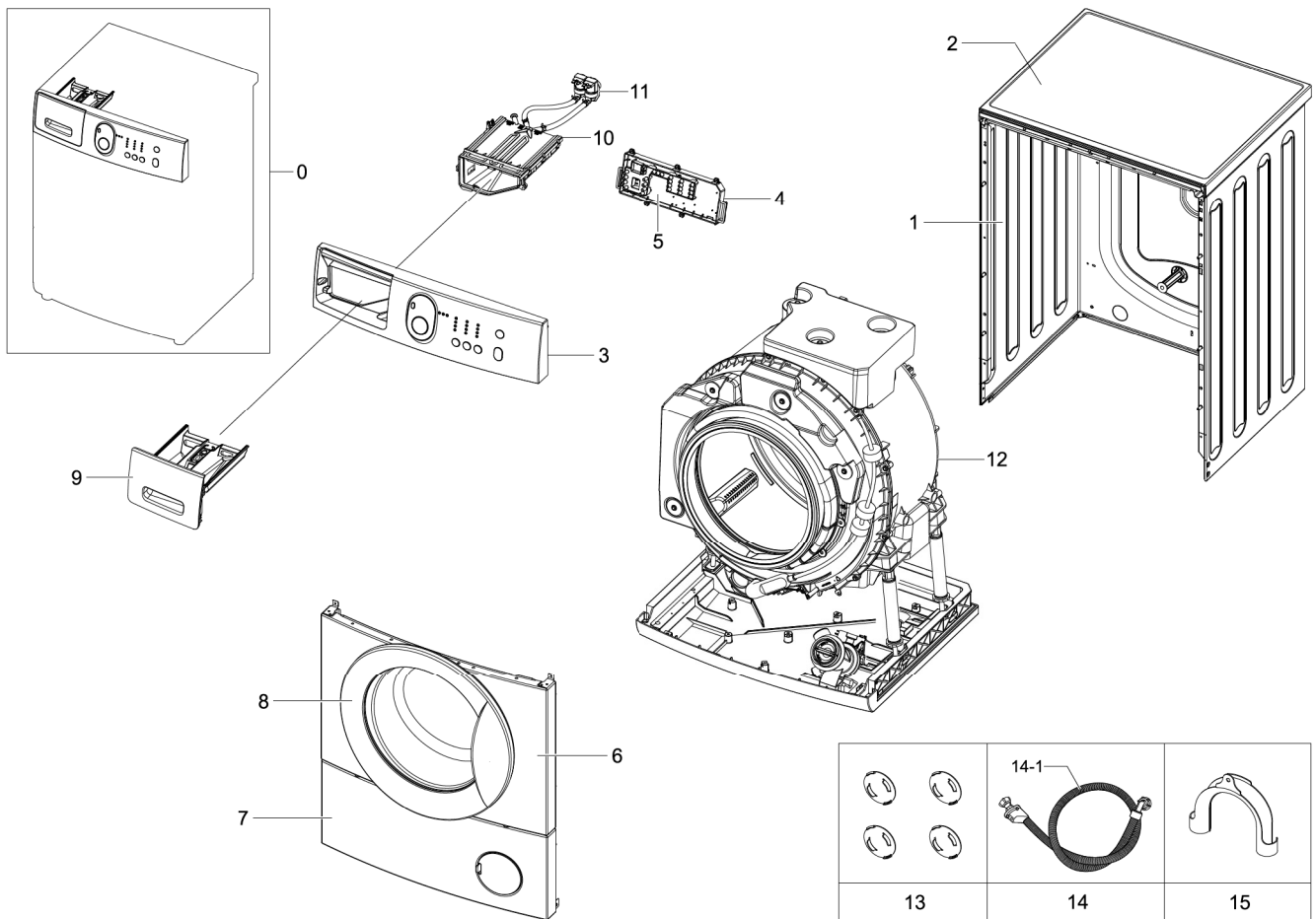

Parts List

No.	Lvl.	Loc.	Material Code	Description & Specification	SNA	Qty.
1	1	W0730	DC97-16256A	ASSY FRAME-9021503; 1142420,AMICA-PJT,902	SNA	1
2	2	W0183	DC97-16299A	ASSY COVER TOP; S-AM,AWSE 12DA,D394.9/ W5	SA	1
3	2	W0178	DC97-16121T	ASSY PANEL CONTROL; S-AM,WF0502NXWG/XEC,B	SA	1
4	2	W0470	DC92-00365A	ASSY PCB MAIN; AMICA,WF A502NGS,5KG,POLAN	SA	1
5	2	W0469	DC92-00366H	ASSY PCB SUB; S-AM,WF0502,5KG,230V/50Hz,B	SNA	1
6	1	W0415	DC97-16254A	ASSY FRAME FRONT-9005391; 1142420,SAM-PJT	SNA	1
7	1	F0131	DC97-16250A	ASSY PAINT FRAME-L; SAM-PJT,9005392,COLAM	SNA	1
8	2	W0459	DC97-16135A	ASSY DOOR; S-AM PJT,WF0602NXW,OD450,WHITE	SA	1

1.1. Frame & Cover Parts

Exploded View

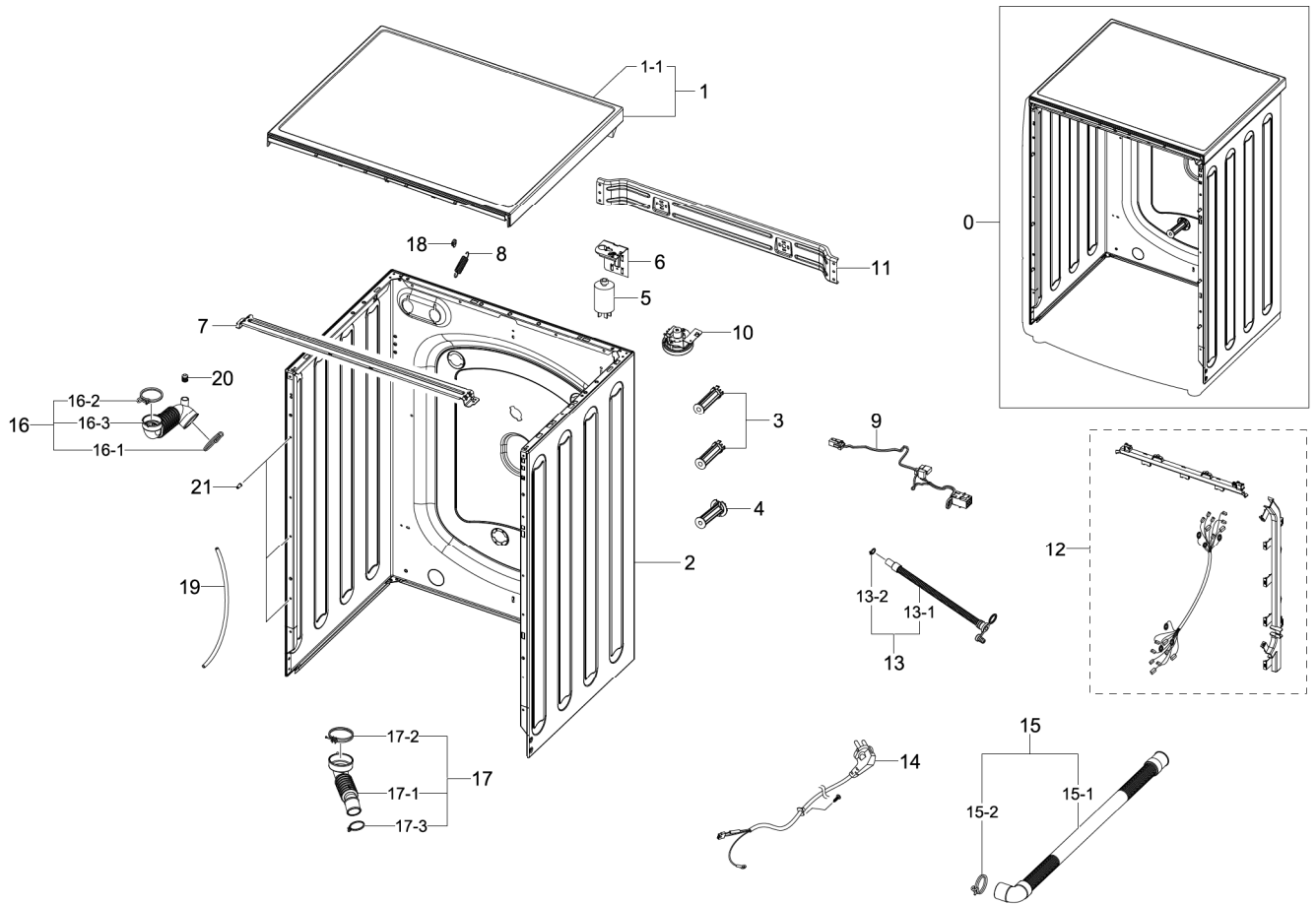

Parts List

No.	Lvl.	Loc.	Material Code	Description & Specification	SNA	Qty.
1	2	W0183	DC97-16299A	ASSY COVER TOP; S-AM,AWSE 12DA,D394.9/W5	SA	1
1-1	3	G0042	DC63-01240A	COVER TOP-(B); ABS,WHITE,8041286	SA	1
2	1	W0730	DC97-16256A	ASSY FRAME-9021503; 1142420,AMICA-PJT,902	SNA	1
3	2	G0004	DC61-02844A	FIXER-TUB(U); SAM-PJT,PP,T2,L52,OD27/25,8	SA	2
4	2	G0005	DC61-02845A	FIXER-TUB(L); SAM-PJT,PP,T2,L61,OD35/25,8	SA	1
5	2	W0229	DC29-00005D	FILTER-EMI; FA-2151T-4 / RDFC-2718,1.2mm	SA	1
6	2	W0227	DC61-02808A	BRACKET-FILTER EMI; WF0602NXW,GI-SGCC,T0.	SA	1
7	2	G0006	DC63-01242A	FRAME-PLATE; 8017921,W580/T1.0,NTR	SA	1
8	2	W0630	DC61-02862A	SPRING ETC-HANGER; SAM-PJT,HSWR-SWRH,OD14	SA	1
9	2	W0224	DC93-00016D	ASSY WIRE HARNESS-PUMP; S-AM,PUMP WIRE	SA	1
10	2	W0607	DC96-01703A	ASSY SENSOR PRESSURE; Hook	SA	1

1.2. Assy Tub & Drum

Exploded View

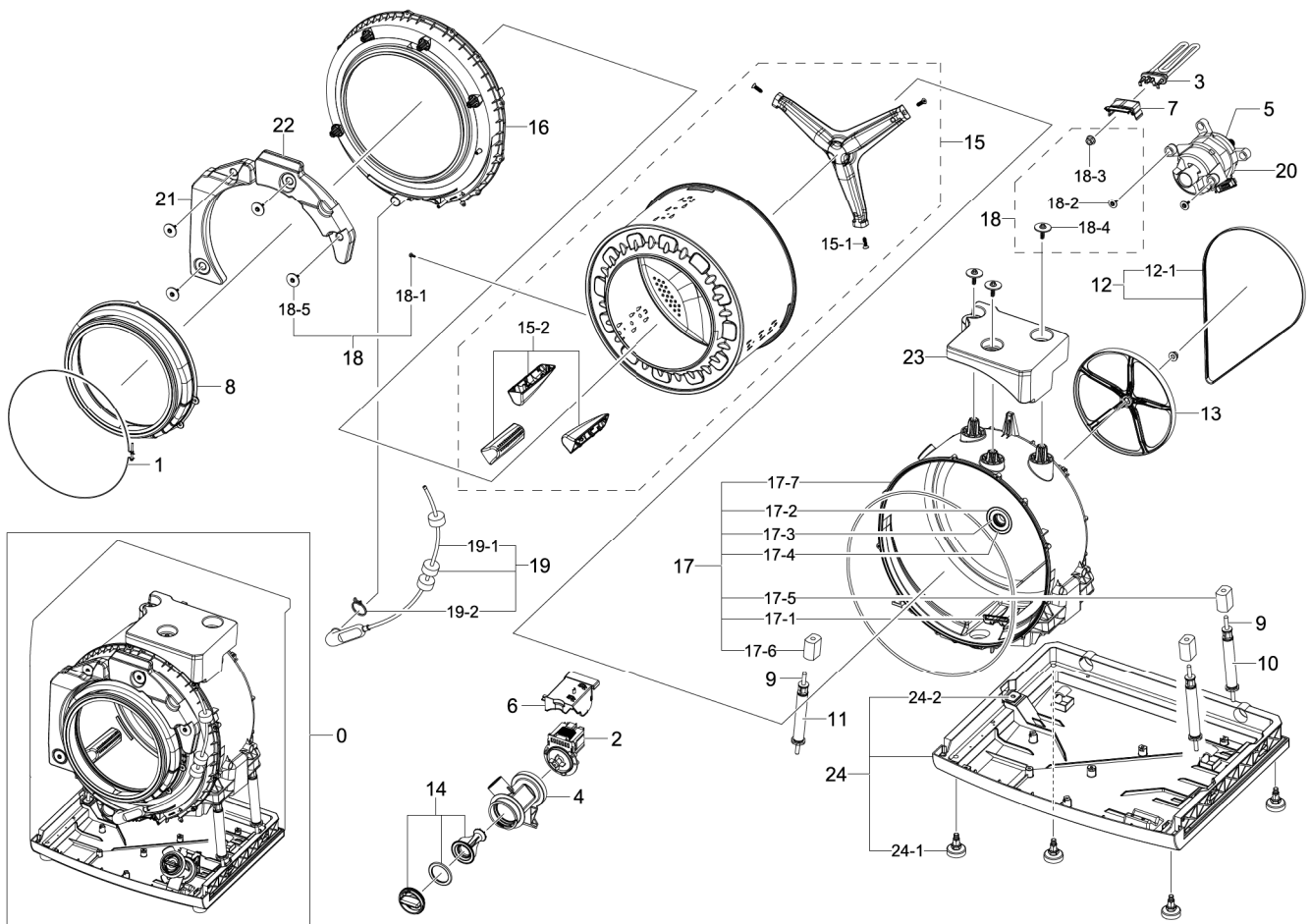

Parts List

No.	Lvl.	Loc.	Material Code	Description & Specification	SNA	Qty.
0	1	W0502	DC90-04134A	ASSY TUB & DRUM; S-AM PJT,WF0502NXWG	SNA	1
1	2	M0038	6049-001182	ASSY CLAMP DIAPHRAGM; S-AM PJT,8010380,wi	SA	1
2	2	M0022	DC31-00030A	PUMP-DRAIN; B20-6 / S3001,220V-240V,50Hz,	SA	1
3	2	W0237	DC47-00034A	HEATER-WASH; S-AM,SUS316L,2000,8.69,230V,	SA	1
4	2	W0479	DC61-02777A	CASE-PUMP; WF-A602NBS,PP,T3.0,OD80,L108,N	SA	1
5	2	W0236	DC61-02811A	BRACKET-MOTOR; WF0602NXW,GI,T0.5,W120,L11	SA	1
6	2	W0213	DC63-00830A	COVER-PUMP; -,PP,-,W59.0,L77,V0 GRADE,WHT	SC	1
7	2	W0235	DC63-01224A	COVER-HEATER; S-AM,ABS,T2.5,W91.4,L46.3,V	SA	1

1.3. Assy Frame Front & Door

Exploded View

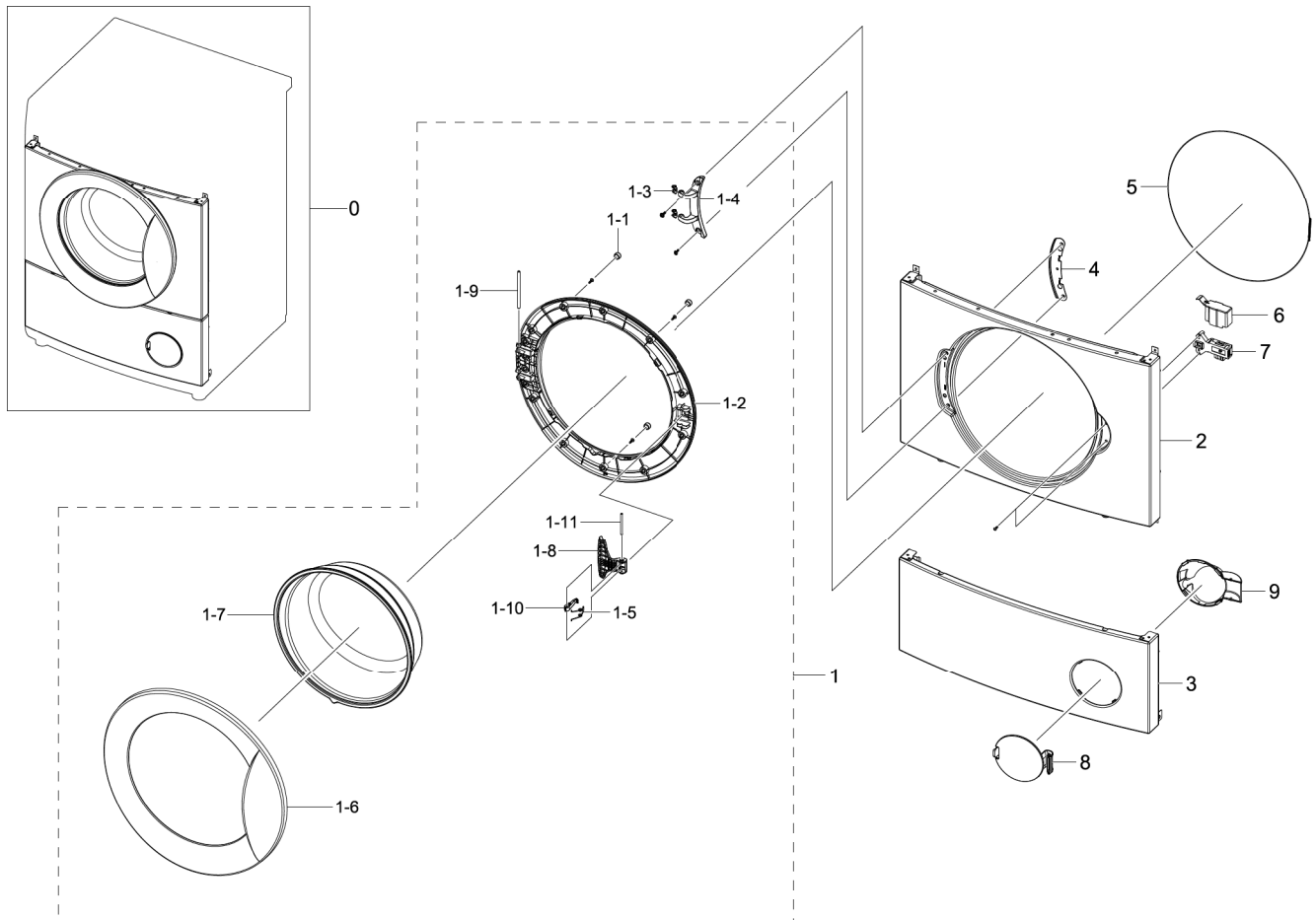

Parts List

No.	Lvl.	Loc.	Material Code	Description & Specification	SNA	Qty.
1	2	W0459	DC97-16135A	ASSY DOOR; S-AM PJT,WF0602NXW,OD450,WHITE	SA	1
1-1	3	W0468	DC67-00530B	CAP-SCREW; WF0602,SILICON,WHT,H/NESS 45/S	SA	3
1-2	3	W0439	DC61-02802A	HOLDER-GLASS; WF0602NXW,PP,T2.8,W449,L449	SA	1
1-3	3	W0220	DC61-02803A	GUIDE-HINGE; WF0602NXW,POM,T1.5,W14.5,L12	SA	2
1-4	3	W0219	DC61-02812A	HINGE-DOOR; WF0602NXW,ALDC,T8.8,W155.5,L4	SA	1
1-5	3	W0142	DC61-02858A	SPRING ETC-LEVER; SAM-PJT,HSWR-SWRH,T1.4	SA	1
1-6	3	W0440	DC63-01225A	COVER-DOOR; WF-A602NBS,ABS,T2.8,W450,L450	SA	1
1-7	3	F0129	DC64-02428A	DOOR GLASS; 8030889 / SAM-PJT,GLASS,T5,OD	SA	1

1.4. Assy Panel Control & Drawer

Exploded View

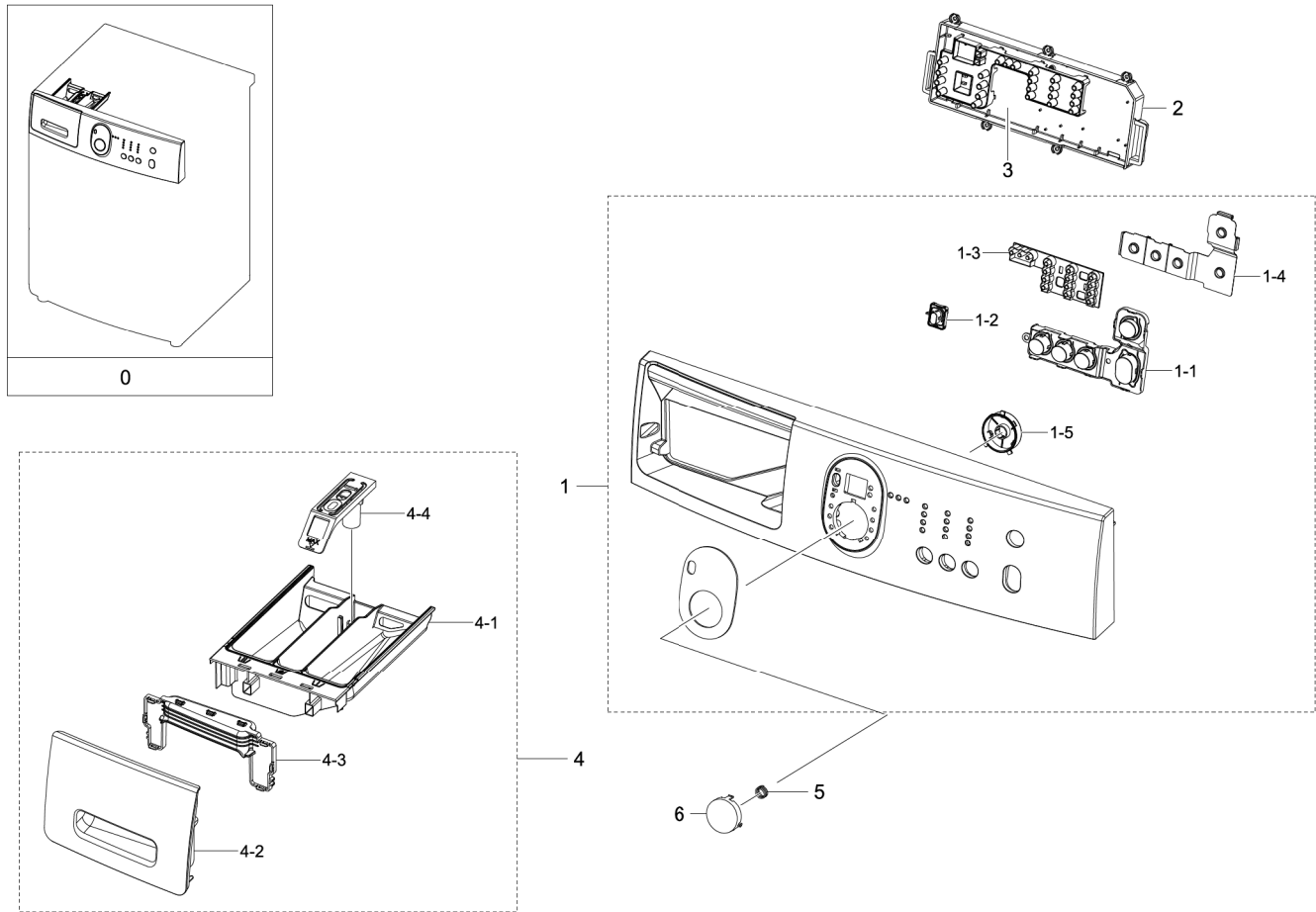

Parts List

No.	Lvl.	Loc.	Material Code	Description & Specification	SNA	Qty.
1	2	W0478	DC97-16121T	ASSY PANEL CONTROL; S-AM,WF0502NXWG/XEC,B	SA	1
1-1	3	W0196	DC64-02395A	BUTTON-PUSH(F); S-AM,ABS,NTR,FUNCTION	SA	1
1-2	3	G0017	DC64-02396A	BUTTON-PUSH(D); S-AMICA,ABS,D26,NTR	SA	1
1-3	3	W0188	DC64-02399A	DECORATION-LED; S-AM,PMMA,T2.0,TRP	SA	1
1-4	3	W0221	DC64-02485A	BUTTON-RUBBER; S-AM / WF0602,SILICON,NTR,	SA	1
1-5	3	W0436	DC61-02814A	GUIDE-BUTTON; S-AM,ABS,T1.2,W43,L13,BLK	SA	1
2	2	W0470	DC92-00365A	ASSY PCB MAIN; AMICA,WF A502NGS,5KG,POLAN	SA	1
3	2	W0469	DC92-00366H	ASSY PCB SUB; S-AM,WF0502,5KG,230V/50Hz,B	SNA	1
4	2	W0216	DC97-16137A	ASSY DRAWER; S-AM PJT,WF0602NXW,PP+ABS,NO	SA	1

1.5. Assy Housing Drawer

Exploded View

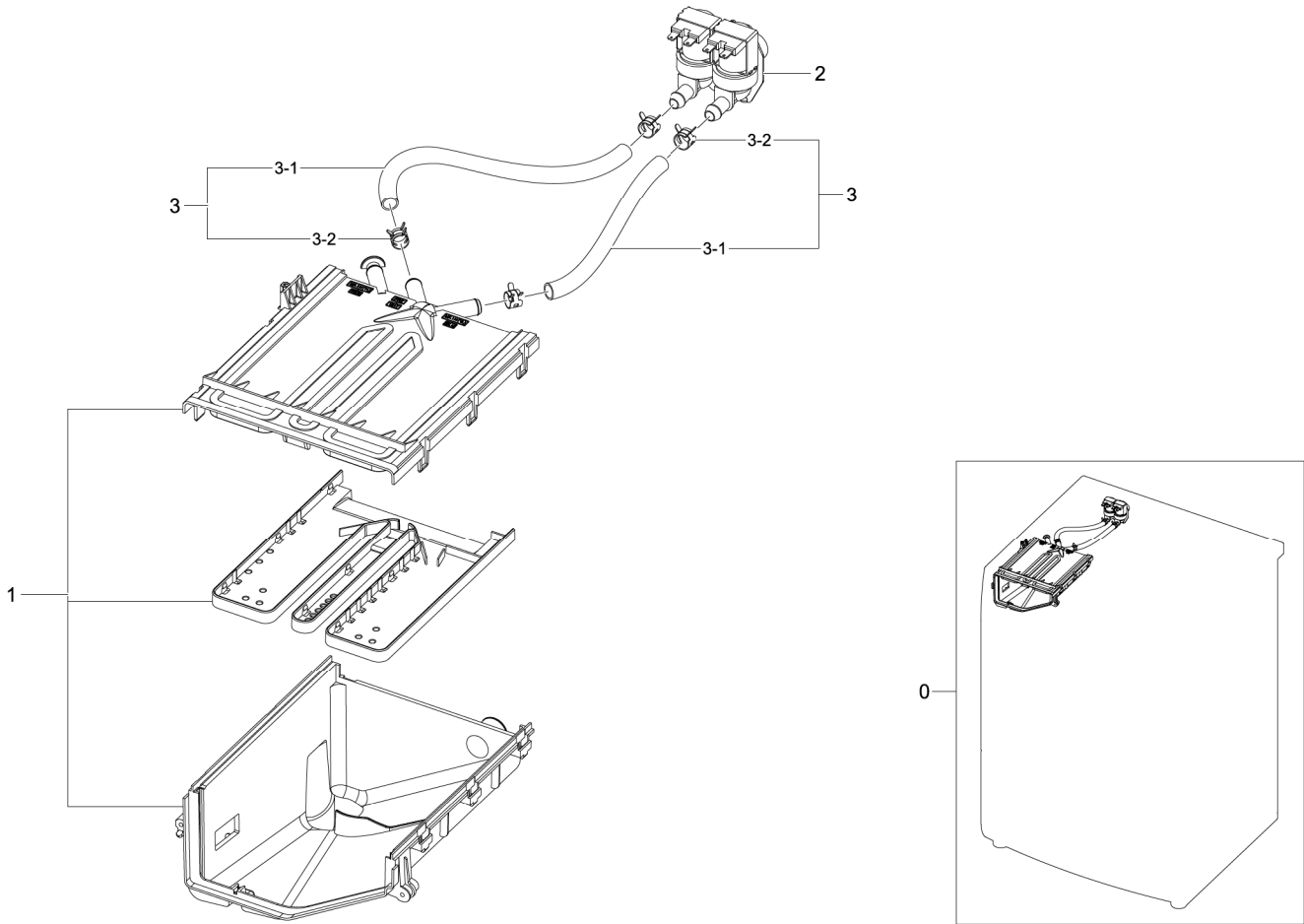

Parts List

No.	Lvl.	Loc.	Material Code	Description & Specification	SNA	Qty.
1	2	W0163	DC97-16136A	ASSY HOUSING DRAWER; S-AM PJT,WF0602NXW,P	SA	1
2	2	W0078	DC62-30312L	VALVE WATER; 220-240,10,D-2	SA	1
3	2	P0031	DC97-16238A	ASSY HOSE DRAWER-705828; 1141817,AMICA-PJ	SA	1
3-1	3	W0151	DC67-00514A	HOSE-DRAWER; 8017200,EPDM,BLK	SA	2
3-2	3	F0108	DC72-00093A	CLIP-RING; 8018311,HSWR,T1.8	SA	4