



RL34E* RL40E*
RL34S* RL40S*
RL34H* RL40H*
RL37H* RL40W*
RL34L* RL40Z*
RL37L* RL40L*
RL40U*

Refrigerator User manual

English

Imagine the possibilities

Thank you for purchasing a Samsung product.
To receive a more complete service,
please register your product at
www.samsung.com/global/register

Free Standing Appliance



features of your new refrigerator

KEY FEATURES OF YOUR NEW REFRIGERATOR

Your Samsung Refrigerator comes equipped with innovative storage and energy-efficient features.

- **Indirect refrigerating and Frost-free**

The refrigerator is indirect refrigerating and frost-free with its automatic de-frost function and even distributed temperature in the compartments.

- **Dual-loop (RL40E*, RL40H*, RL40Z*, RL40U*, RL34E*, RL34H*, RL37H*)**

The temperatures in the refrigerator and freezer can be displayed and controlled separately.

- **Left/right door opening**

The direction of the door opening can be adjusted according to the user's habit.





For easy future reference write the model and serial number down. You will find your model number on the left hand side wall of the refrigerator.

Model # _____



Serial # _____

safety information







SATETY INFORMATION

-  **WARNING** • Before operating the appliance, please read this manual thoroughly and retain it for your reference.
-  **WARNING** • Because these following operating instructions cover various models, the characteristics of your refrigerator may differ slightly from those described in this manual.

CATTION/WARNING SYMBOLS USED

 WARNING	Indicates that a danger of death or serious injury exists.
 WARNING	Indicates that a risk of personal injury or material damage exists.

OTHER SYMBOLS USED

	Represents something you must NOT do.
	Represents something you must NOT disassemble.
	Represents something you must NOT touch.
	Represents something you must follow.
	Indicates that you must disconnect the power plug from the socket.
	Represents a ground is needed to prevent electric shock.
	It is recommended that this symbol be handled by service man.

Please follow up specifically as these warning symbols are purposed to prevent you and the others from being injured.

After reading this section, please keep it properly for future reference.

- This refrigerator must be properly located in accordance with the manual before it is used.
- Use this appliance only for its intended purpose as described in this instruction manual.
- We strongly recommend that any servicing be performed by a qualified individual. R600a or R134a can be used as a refrigerant. Check the compressor label on the rear of the appliance and the rating label inside the fridge to see which refrigerant is used for the refrigerator.
-  • In case of R600a refrigerant, this gas is natural gas with high environmental compatibility that is, however, also combustible. When transporting and installing the appliance, care should be taken to ensure that no parts of the refrigerating circuit are damaged.
- Refrigerant squirting out of the pipes could ignite or cause an eye injury. If leak is detected, avoid any naked flames or potential sources of ignition and air the room in which the appliance is standing for several minutes.

safety information





- In order to avoid the creation of a flammable gas-air mixture if a leak in the refrigerating circuit occurs, the size of the room in which the appliance may be sited depends on the amount of refrigerant used.
- Never start up an appliance showing any signs of damage. If in doubt, consult your dealer. The room must be 1m³ in size for every 8g of R600a refrigerant inside the appliance.
- The amount of refrigerant in your particular appliance is shown on the identification plate inside the appliance.
- Please dispose of the packaging material for this product in an environmentally friendly manner.
- Pull the power plug out of the socket before changing the interior light of the refrigerator. _Otherwise, there is a risk of electric shock.

SEVERE WARNING SIGNS



- Do not install the refrigerator in a damp place or place where it may come in contact with water.
- -Deteriorated insulation of electrical parts may cause an electric shock or fire.
- Do not place this refrigerator in direct sunlight or expose to the heat from stoves, room heaters or other appliance.
- Allow sufficient space to install the refrigerator on a flat surface.-If your refrigerator is not level ,the internal cooling system may not work correctly.
- Do not plug several appliances into the same multiple power board. The refrigerator should always be plugged into its own individual electrical which has a voltage rating that matched the rating plate.
 - This provides the best performance and also prevents overloading house wiring circuits, which could cause a fire hazard from overheated wires.
- Never unplug your refrigerator by pulling on the power cord. Always grip plug firmly and pull straight out from the outlet.
 - Damage to the cord may cause a short-circuit, fire and/or electric shock.
- Make sure that the power plug is not squashed or damaged by the back of the refrigerator.
- Do not bend the power cord excessively or place heavy articles on it.
 - This constitutes a fire hazard.
- Have the power cord repaired or replaced immediately by the manufacturer or its service agent if power cord has become frayed or damaged.
- Do not use a cord that shows cracks or abrasion damage along its length or at either end. If the power cord is damaged, have it replaced immediately by the manufacturer or its service agent.
- When moving the refrigerator, be careful not to roll over or damage the power cord.
- Do not insert the power plug with wet hands.
- Unplug the refrigerator before cleaning and making repairs.
- Do not use a wet or damp cloth when cleaning the plug.
- Remove any foreign matter or dust from the power plug pins.
 - Otherwise there is a risk of fire.
- If the refrigerator is disconnected from the power supply, you should wait for at least ten minutes before plugging it back.
- If the wall socket is loose, do not insert the power plug.
 - There is a risk of electric shock or fire.
- The appliance must be positioned so that the plug is accessible after installation.

- 
 - The refrigerator must be grounded.
 - You must ground the refrigerator to prevent any power leakages or electric shocks caused by current leakage from the refrigerator.
- 
 - Never use gas pipes, telephone lines or other potential lightning rods as ground.
 - Improper use of the ground plug can result in electric shock.
- Do not disassemble or repair the refrigerator by yourself.
 - You run risk of causing a fire, malfunction and/or personal injury.
- If you smell pharmaceutical or smoke, pull out power plug immediately and contact your Samsung electronics service center.
- Keep ventilation openings, in the appliance enclosure or in the built-in structure, clear of obstruction.
- Do not use mechanical devices or other means to accelerate the defrosting process, other than those recommended by the manufacturer.
- Do not damage the refrigerant circuit.
- Do not use electrical appliances inside the food storage compartments of the appliance, unless they are of the type recommended by the manufacturer.
- The appliance is not intended for use by persons (including children) with reduced physical, sensory or mental capabilities, or lack of experience and knowledge, unless they have been given supervision or instruction concerning use of the appliance by a person responsible for their safety.
- Children should be supervised to ensure that they do not play with the appliance.
- If the supply cord is damaged, it must be replaced by the manufacturer, its service agent or similarly qualified persons in order to avoid a hazard.
- Do not let children hang on the door. If not, a serious injury may occur.
- Do not touch the inside walls of the freezer or products stored in the freezer with wet hands.
 - This may cause frostbite.
- If the refrigerator is not to be used for a long period of time, pull out the power plug.
 - Deterioration in the insulation may cause fire.
- Do not store articles on the top of the appliance.
 - When you open or close the door, the articles may fall and cause personal injury and/or material damage.

CAUTION SIGNS



- This product is intended only for the storage of food in a domestic environment.
- CAUTION** • Manufacturer's recommended storage times should be adhered to.
 Refer to relevant instructions
- Bottle should be stored tightly together so that they do not fall out.
- Do not place carbonated or fizzy drinks in the freezer compartment
- Do not overfill the refrigerator with food.
 - When you open the door, an item may fall out and cause personal injury or material damage.
- Do not put bottles or glass containers in the freezer.
 - When the contents freeze, the glass may break and cause personal injury.
- Do not spray inflammable gas near the refrigerator.
 - There is a risk of explosion or fire.
- Do not directly spray water inside or outside the refrigerator.
 - There is a risk of fire or electric shock.

safety information

- Do not store volatile or flammable substances in the refrigerator.
 - The storage of benzene, thinner, alcohol, ether, LP gas and other such products may cause explosions.
- Do not re-freeze frozen foods that have thawed completely.
- Do not store pharmaceuticals products, scientific materials or temperature-sensitive products in the refrigerator.
 - Products that require strict temperature controls must not be stored in the refrigerator.
- Do not put a container filled with water on the refrigerator.
 - If spilled, there is a risk of fire or electric shock..

CAUTION SIGNS FOR CLEANING

- Do not insert your hands into the bottom area under the appliance.
 - Any sharp edges may cause personal injury.
- Never put fingers or other objects into the dispenser hole.
 - It may cause personal injury or material damage.
- If the refrigerator is disconnected from the power supply, you should wait for atleast five minutes before plugging it back.

WARNING SIGNS FOR DISPOSAL

- When disposing of this or other refrigerator/s, remove the door/door seals, doorlatch so that small children or animals cannot become trapped inside.
- Leave the shelves in place so that children may not easily climb inside.
R600a or R134a is used as a refrigerant. Check the cimpessor label on the rear of the appliance or the rating label inside the fridge to see which refrigerant is used for your refrigerator. When this product contains flammable gas(Refrigerant R600a)contact your local authority in regard to safe disposal of this product.
- Cyclopentane is used as a insulation blowing gas. The gases in insulation material require special disposal procedure. Please contact your local authorities in regard to the environmentally safe disposal of this product. Ensure that none of the pipes on the back of the appliances are damaged prior to disposal. The pipes shall be broke in the open space.



CAUTION

In the event of a power failure, call the local office of your Electricity Company and ask how long it is going to last.

Most power failures that are corrected in an hour or two will not affect your refrigerator temperatures.

However, you should minimize the number of door openings while the power is off.

But should the power failure last more than 24hours, remove all frozen food.

For doors or lids fitted with locks and keys, the keys be kept out of the reach of children and not in the vicinity of the refrigerating appliance, in order to prevent children from being locked inside.

safety information

ADDITIONAL TIPS FOR PROPER USAGE



- Allow the appliance to stand for 2 hours after installation.
- To get best performance of product,
 - Do not place foods too closely in front of the vents at the rear of the appliance as it can obstruct free air circulation in the freezer compartment.
 - Wrap the food up properly or place it in airtight containers before put it into the fridge freezer
 - Do not put any newly introduced food for freezing near to already frozen food.
- Do not place carbonated or fizzy drinks in the freezer compartment
- Please observe maximum storage times and expiry dates of frozen goods.
- There is no need to disconnect the refrigerator from the power supply if you will be away for less than three weeks. But, remove all the food if you are going away for the three weeks or more. Unplug the refrigerator and clean it, rinse and dry.
- Most power failures that are corrected in an hour or two will not affect your refrigerator temperatures. However, you should minimize the number of door openings while the power is off. But should the power failure last more than 24 hours, remove all frozen food.
- If the key is provided with refrigerator, the keys should be kept out of the reach of children and not in the vicinity of the appliance.
- The appliance might not operate consistently (possibility of defrosting of contents or temperature becoming too warm in the frozen food compartment) when sited for an extended period of time below the cold end of the range of temperatures for which the refrigerating appliance is designed.
- Do not store food which goes bad easily at low temperature, such as bananas, melons.
- Place the ice tray at the originally provided position by manufacturer in order to achieve optimal ice-freezing.
- Your appliance is frost free, which means there is no need to manually defrost your appliance, as this will be carried out automatically.
- Temperature rising during the defrost can comply with ISO requirement. But If you want to prevent an undue rise in the temperature of the frozen food while defrosting the appliance, please wrap the frozen food in several layers of paper such as newspaper.
- Any increase in temperature of frozen food during defrosting can shorten its storage life.

contents

SETTING UP YOUR REFRIGERATOR	09	Installing the fridge / freezer
	09	caution signs for cleaning

09

OPERATING YOUR REFRIGERATOR	10	Preparing the fridge / freezer
	10	Using the control features
	13	Storing food in the refrigerator
	14	Making ice
	15	Using The Water Dispenser (Optional)

10

17	Cleaning The Water Dispenser
18	Replacing the interior light
18	Removing vegetable tray cover(optional)
18	Reversing the door swing
23	View of your fridge / freezer

TROUBLESHOOTING

26

setting up your refrigerator

INSTALLING THE FRIDGE/FREEZER

1. Allow an adequate space and install the fridge/freezer on a firm, level floor.

- If the appliance is not level, there may be unusual noises and poor cooling.
- Wait for at least one hour before plugging the appliance in.

2. Clean the fridge/freezer.

- Wipe and clean the appliance inside and outside with a damp cloth.

3. Plug the fridge/freezer into a wall socket used exclusively by this appliance.

- This appliance must be properly grounded.

4. Place the food in the fridge/freezer.

- It is recommended that you wait for the appliance to cool for 2-3 hours before storing food in it.

CAUTION SIGNS FOR CLEANING

If the front of the appliance is slightly higher than the rear, the door can be closed more easily.

1. The appliance tilts down to the left.

Turn the left adjusting leg in the direction of the arrow with a flat head screwdriver until the appliance is level.

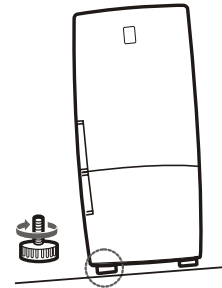

2. The appliance tilts down to the right.

Turn the right adjusting leg in the direction of the arrow with a flat head screwdriver until the appliance is level.

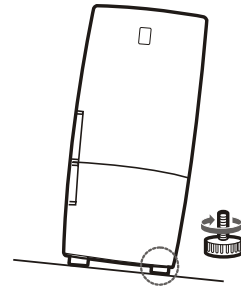

3. Allow the enough space for opening drawers.

Drawers can be easily opened with this condition.

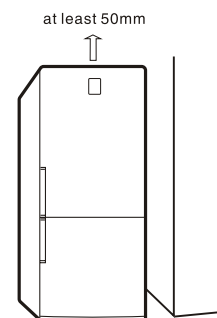
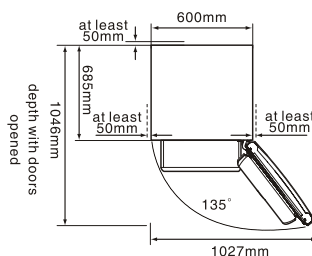

operating your refrigerator

PREPARING THE FRIDGE/FREEZER

To prepare your appliance for use and to check that it is running correctly, take the following steps.

- Install all shelves and compartments removed during transport in the correct positions.
- Clean the fridge/freezer and accessories to remove any dust that accumulated during packing and shipping.
- The interior light of the appliance will light up when fridge door is open.
- Set the temperature control to the coldest temperature and let the refrigerator operate for one hour. The freezer should get slightly chilled and the motor should run smoothly with soft hum.
- Your fridge/freezer is operated by a compressor which switches "Operation" to maintain the internal temperature. For the first five minutes after initial start-up, it may be slightly noisy. This is quite normal and does not represent a fault. Store food once the temperature in the refrigerator is sufficiently low. It takes a few hours after starting the refrigerator to reach the proper temperature.
- If the appliance does not operate correctly, check the electricity supply. If the problem persists, contact your dealer.

USING THE CONTROL FEARURES

A:RL40E*,RL40H*,RL40Z*,RL40U*,RL34E*,RL34H*,RL37H*

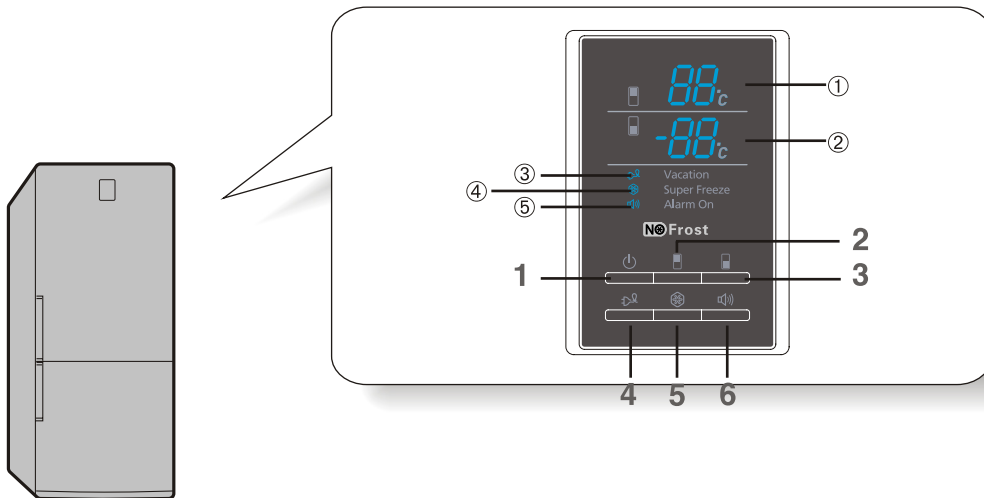

1. Operation Button

- If you want to turn off, keep pressing for 3 seconds.

 Do not disassemble the refrigerator with unit turned on.
- It may cause electric shocks or other damages.

2. Fridge temp Button

- To change the refrigerator temperature:
 - Press the REF.TEMP button.
The current setting temperature is displayed (①).
 - Press the REF.TEMP button one or more times until the required temperature is displayed (①).
 - When you complete the setting of refrigerator temperature, the refrigerator temperature display (①) flashes 5 times.
The temperature changes in sequence. After +7°C, the display returns to +1°C
Refrigerator temperature range: +1°C to +7°C.

3. Freezer temp Button

- In the normal model, the temperature displayed (②) is the setting temperature of the freezer.
- To change the freezer temperature:
 - Press the FRE.TEMP button.
The current setting temperature is displayed (②).
 - Press the FRE.TEMP button one or more times until the required temperature is displayed (②).
- The temperature changes in sequence. After -25°C, the display returns to -14°C again.
- Freezer temperature range: -14°C to -25°C.

4. Vacation Button

- If you are going on a long vacation or business trip or you do not need to use the refrigerator, press the Vacation button.
- The refrigerator is switched off but the freezer remains on.
- The Vacation indicator (③) remains on while the Vacation function is operating.

-  - You must empty the refrigerator before pressing the Vacation button (③).
- CAUTION** - There is no need to disconnect the refrigerator from the power supply if you will be away for less than three weeks. But remove all the food if you are going away for three weeks or more, unplug the refrigerator and clean, rinse and dry it.

5. Super Freeze Button

- Switch for the fast freeze function on or off.
- Use when you wish to freeze foods quickly.
- The Super Freeze indicator (④) remains on while the fast freeze function is running.
- While this function is selected, the refrigerating device remains switched on continuously and produces a very low temperature inside the freezer.
- The super freeze function switches off automatically. When the fast freeze process is completed, the Super Freeze indicator (④) switches off and the freezer switches back to the previous setting temperature.
- To release Super freezer function, press the button again.

-  If you need to freeze large amount of food stuff, set the temperature of freezer compartment as the coldest temperature before you turn on the Super Freeze Button.

Operating your refrigerator

6. Alarm On Button

- When you press the Alarm on button, it's activated and displayed (⑤). Alarm will go off after a certain period of time when the refrigerator door is kept open.
- If you want to turn off the Alarm when it is set to Alarm On, press the button one more time to cancel the alarm.

-  • The freezer door does not have an alarm function to indicate that the door is open or closed.
If the Super Freeze, Vacation mode is already selected and you press one of the
 - other buttons, the current mode is cancelled and the mode corresponding to the button pressed is selected.

B:RL40S*,RL40W*,RL40L*,RL34S*,RL34L*,RL37L*

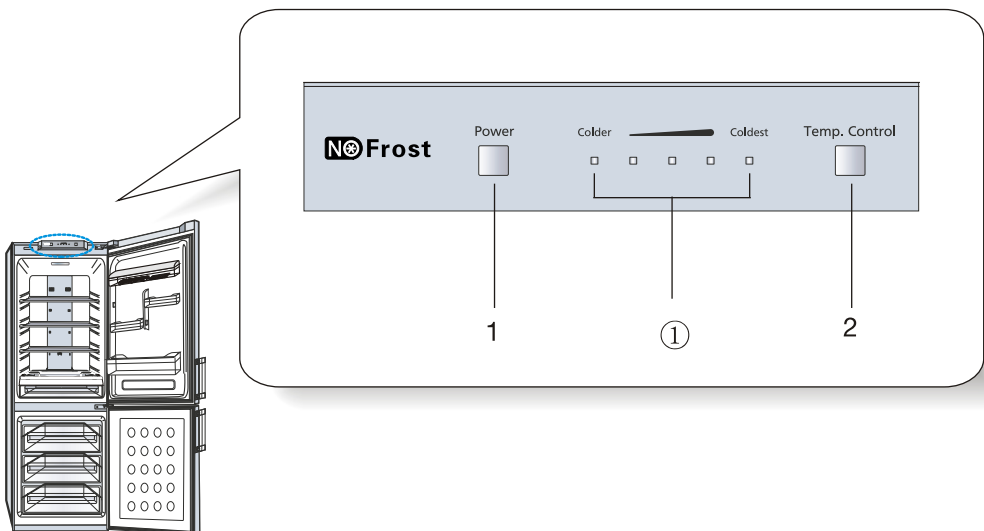

1. Power Button

- If you want to turn off, keep pressing for 3 seconds.

-  Do not disassemble the refrigerator with unit turned on.
- It may cause electric shocks or other damages.

2. Temp. Control Button

- Press the Temp. Control button to control the refrigerator temperature.
- Initially, the mid-point temperature setting is selected.
There are five temperature settings, represented by five indicator lights (①).
- When all lights are on, the temperature is at its coldest.
- Press the Temp. Control button one or more times until the required temperature is set.
- The freezer temperature will be adjusted automatically according to the refrigerator temperature.
-  If you need to freeze large amount of food stuff, set the temperature of freezer compartment as the coldest temperature at 24hours before.

STORING FOOD IN THE FRIDGE OR FREEZER

When storing food in the appliance, follow the recommendations below:

- Allow warm food and beverages to cool down before storing them in the appliance.
- Ensure that food is well-wrapped or covered with airtight containers before it is stored. This will prevent food from dehydrating, deteriorating in colour or losing flavor and will help maintain freshness. It will also prevent cross-flavouring.
- Never let any oil or grease come into contact with the plastic fittings or door seals, as these materials easily become porous.
- Never store any explosive substances inside the appliance. High-proof alcohol should only be stored upright in tightly sealed containers.

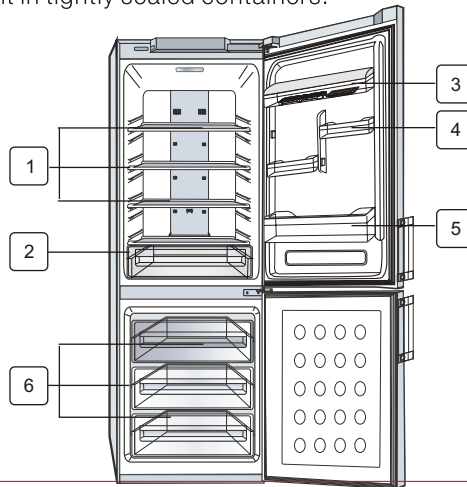

To get the best energy efficiency of this product, please leave all selves, drawers and baskets on their original position like as above illustration.

Storing Food in the Fridge

1 PRESERVATION CABINET SHELF	<ul style="list-style-type: none"> • Place food in storage containers and lay the items out at suitable intervals. • The storage shelf is of an unbreakable, transparent material, so that you can use it safely.
2 TRAY VEG	<ul style="list-style-type: none"> • Vegetable and fruit can be stored in this compartment. • If you require more space to store fruit and vegetables, it is possible to remove the drawers. • A declared storage volume of fresh food storage compartment is calculated when the fresh safe drawers are removed.
3 DAIRY GUARD	<ul style="list-style-type: none"> • Place Egg tray in this compartment (Egg tray is used to store eggs). • Store small packed foods, like milk, yogurt and beverages.
4 VARIETY GUARD	<ul style="list-style-type: none"> • Store fatty foods, like butter and cheese. • Store small packed foods, like milk, yogurt and beverages.
5 LARGE BOTTLE GUARD	<ul style="list-style-type: none"> • Store small bottles and cartons (1 litre) of beer, milk, juice ,large bottles and cartons(1.5 litres).

operating your refrigerator

Storing Food in the Freezer

6

FREEZER DRAWER

- Store fresh meat and fish or dried foods, which are divided into suitably sized portions.
- Do not store food which goes bad easily at low temperature, such as bananas, melons.
- Do not put any newly introduced food for freezing near to frozen food.
- Do not place carbonated or fizzy drinks in the freezer compartment.



- Your appliance is frost free, which means there is no need to manually defrost your appliance, as this will be carried out automatically.
- Temperature rising during the defrost can comply with ISO requirement, But if you want to prevent on undue rise in the temperature of the frozen food while defrosting the appliance. Please wrap the frozen food in several layers of newspaper.
- The appliance may not operate consistently (possibility of defrosting the contents or the temperature becoming too warm in the frozen food compartment) when sited for an extended period of time below the cold end of the range of temperatures for which the refrigerating appliance is designed.
- To get more space, you can remove top and a middle freezer drawers since it does not affect thermal and mechanical characteristics. A declared storage volume of frozen food storage compartment is calculated with these drawers removed.

MAKING ICE

1. Pour water into the ice cube maker.

- Fill the ice maker up to about 80% with water.

2. Place the ice cube maker in the freezer drawer.

3. To take out the ice cubes:

- Twist the ice cube maker slightly.

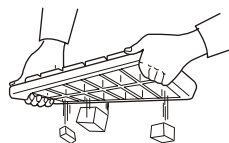

Danger of explosion

- The coldest parts of the refrigerator is the rear panel. This is the best place to store delicate foodstuffs.
- Glass bottles containing liquids that can freeze should never be stored in the freezer as the glass can explode when the contents freeze.



Making ice quickly

- To make a large quantity of ice quickly, press the "Super Freeze" button to select the fast freeze function.

USING THE WATER DISPENSER(OPTIONAL)

With the water dispenser, you can obtain chilled water easily without opening the refrigerator door. In addition, you can save electricity by more than 30% reducing the number of times the door is open.

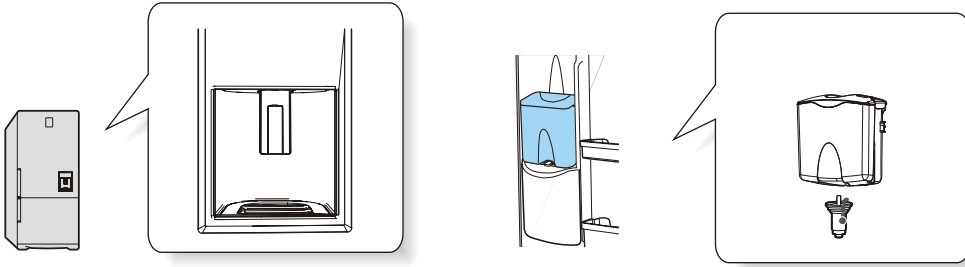

When The Water Dispenser Is Not Used, The Followings Are Recommended

1. Fix the water supply device tightly into the fixing hole.
 - The door will not be closed automatically when the water supply device is pulled out for a long time because of cold leaking.



Filling The Water Tank

1. Push the round cap and fill the water tank up with drinking water.
 - Don't fill up the water tank too much(just over 4.2 litres). It can cause overflow when the door is opening and closing.
 - Don't fill hot water more than 50°C.



2. Push the water dispenser lever with a cup.

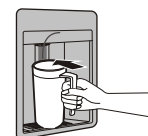

operating your refrigerator



CLEANING THE WATER DISPENSER

Dispensertray

1. Pull out the tray with fingers.
2. Empty the water in the dispenser tray, then clean it using warm water and detergent.

Connection path

Wipe out the connection path and surrounding area with a clean damp cloth.

Water tank/supply device

1. Pull upward and disassemble the hooks on both sides of the large-sized cap.

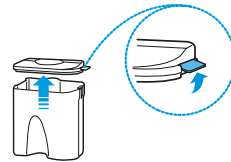

2. Loosen the water supply device by turning it in the direction of the arrow and removing it.



3. Wipe the large-sized cap and the exclusive water tank with warm water and detergent.
 - Hold the cap and pull it upwards to remove it. Clean the cap.



4. After cleaning the water supply device with a soft brush, press the water supply device operation lever, then wash it in running water.



CAUTION

- Clean the water tank frequently if it used to dispense tea or other such beverages. Only use filtered tea. For better hygiene, beverages with a high sugar content (juice, soft drinks) are not recommended.
- Deposits can be cleaned by wiping the tank with a cloth dampened in vinegar or salt water.
- Check that the rubber seal on the water supply device has not slipped off or is not damaged by-a sharp-edged object. Otherwise, it may leak.

operating your refrigerator

REPLACING THE INTERIOR LIGHT



Do not replace LED lamp privately and please contact the specialized repair staff if necessary.

And make it sure that the new LED lamp is the same as the old one.

Do not break the lamp cover .

REMOVING VEGETALE TRAY COVER(OPTIONAL)

- 1.Take out the vegetable tray carefully;
- 2.Pull the vegetable tray cover carefully outwards while pressing the hooks on both sides by fingers.

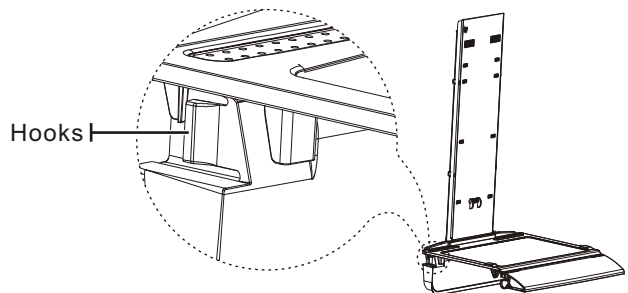

REVERSING THE DOOR SWING

- Read these instructions completely and carefully



- Before reversing the door, ensure first that the refrigerator is disconnect by the plug from the mains. You should take out contents and accessories like door guard from the doors. Be careful not to drop the doors during dissembling or assembling.

1. Handle parts carefully to avoid scratching the paint.
2. Lay out all the screws by their related parts to avoid using them in the wrong places.
3. Provide a non-scratching work surface for the doors. (Ex:blanket)
4. During door reversing, refrigerator should not be stained with oil.

- Tools you will need



Screwdriver



8mm/10mm wrench

Reversing the door swin(1)

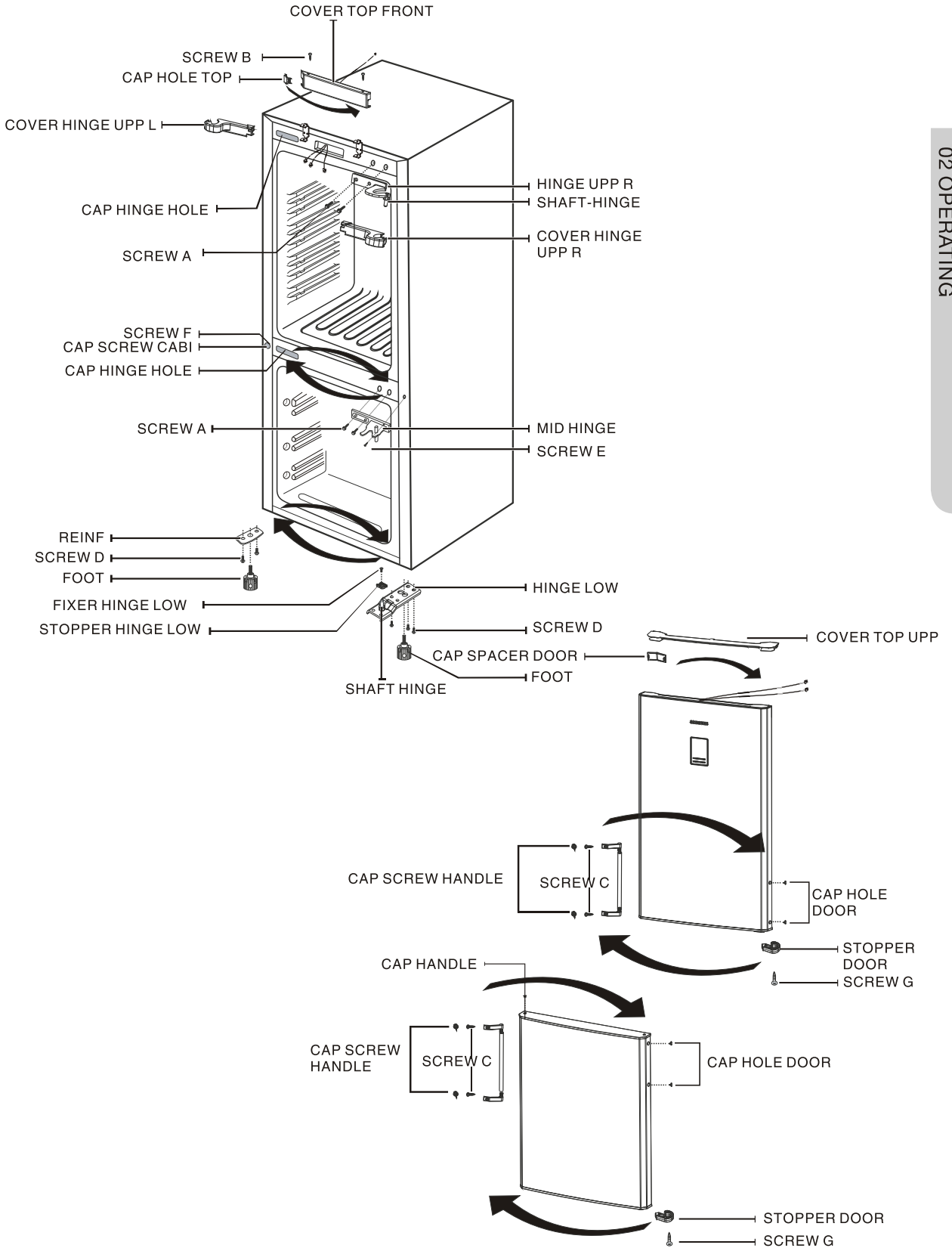

operating your refrigerator

1. Take down the SCREW B which is fixing the COVER TOP FRONT and then COVER TOP FRONT. Pull out the wire inserts.
Take down COVER HINGE UPP R, SCREW A, HINGE UPP R, COVER DOOR UPP and fridge door.
Take down and fix SHAFT-HINGE to the opposite side of HINGE UPP.
Take down CAP HOLE TOP at COVER TOP FRONT and install it on the right of COVER TOP FRONT.
2. Take down SCREW A, SCREW E and MID HINGE of the fixing hinge and then freezer door.
Take down CAP HINGE HOLE, CAP SCREW CABI and SCREW F at left and install them at right.
3. Gently incline the appliance in less than 45 degree, remove the right FOOT and unfasten SCREW D.
Take down right HINGE LOW. Then take down FIX HINGE LOW,SHIFT HINGE and STOPPER HINGE LOW
Reverse STOPPER HINGE LOW and fix it to the left of HINGE LOW with FIXER HINGE LOW andSHIFT HINGE.
4. Take down the left FOOT and unfasten SCREW D.
Take down and fix REINF to the right. Then fix FOOT.
5. Take off the SCREW G and STOPPERDOOR in the freezer door and install them at the left of the door.
Take off CAP HOLEDOR, CAP SCREW HANDLE, SCREW C, ASSY HANDLE BAR, and CAP SPACER DOOR, and install them at the right of the door.
Install CAP HOLEDOR on the left of the door.
6. Fix MID HINGE with SCREW A and SCREW E, and install the freezer door Fix HINGE-LOW to the left and install FOOT.
Put the refrigerator stable and install the fridge door.
Fix HINGE UPP with SCREW A.
7. Fix the wire inserts properly
Install COVER HINGE UPP L and cover it with COVER DOORUPP.
8. Install COVER TOP FRONT and finally fasten SCREW B.

Reversing the door swin(2)

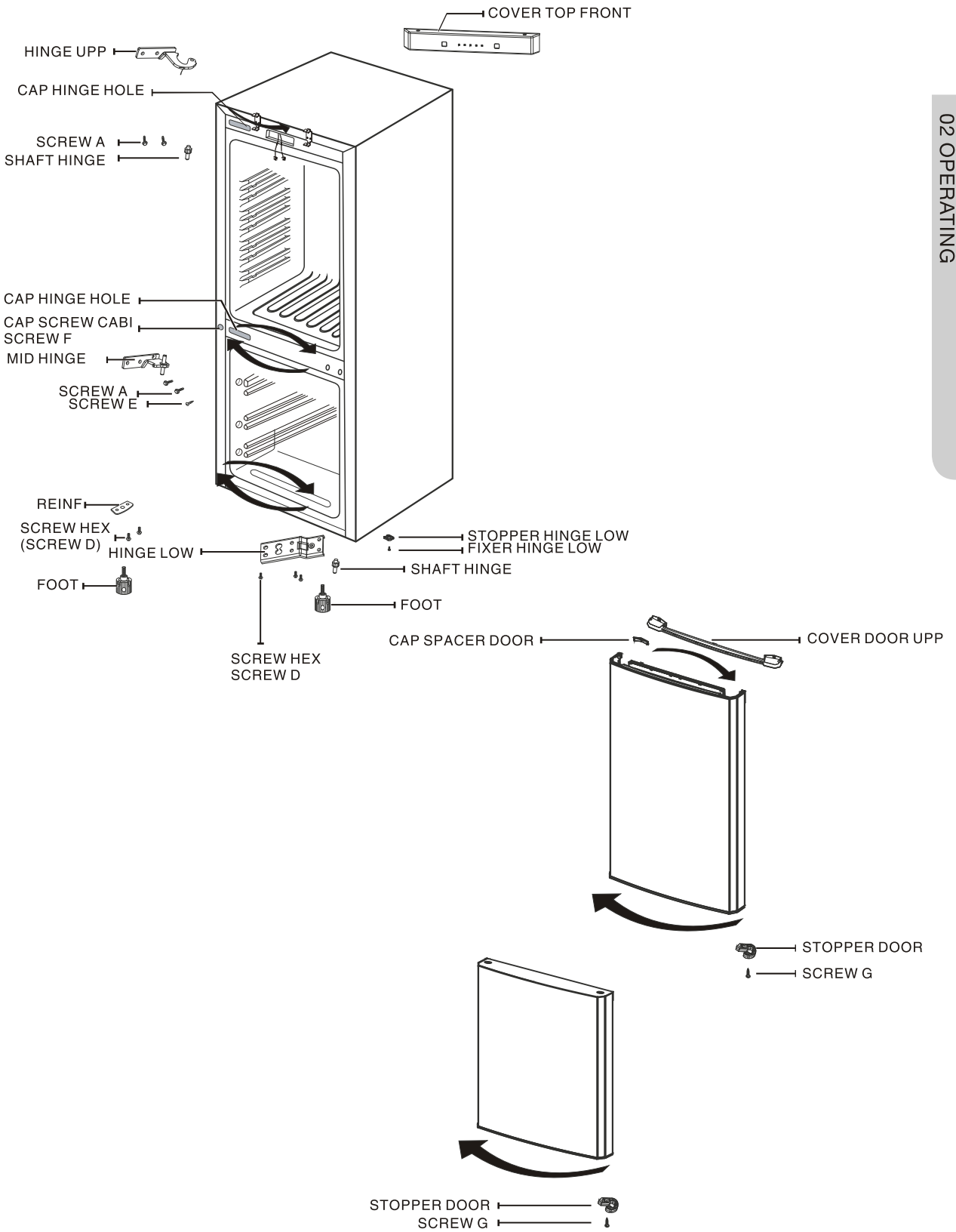

Operating your refrigerator

1. Take down HINGE UPP and SHAFT-HINGE and install them at the opposite side of the HING-UPP.
Take down COVER DOOR UPP and fridge door.
2. Take down SCREW A, SCREW E and MID HINGE, and then the refrigerator door.
Take down CAP HINGE HOLE, CAP SCREW CABI and SCREW F at left and install them at right.
3. Gently incline the appliance in less than 45 degree, remove the right side FOOT, and unfasten the SCREW D.
Take down HINGE LOW, FIXER HINGE LOW ,SHIFT HINGE and STOPPER HINGE LOW.
Reverse and fix STOPPER HINGE LOW with FIXER HINGE LOW to the left of HINGE LOW and SHIFT HINGE.
4. Take down left FOOT and unfasten SCREW D.
Take down and fix REINF to the right.
Then install FOOT.
5. Take down SCREW G and STOPPER DOOR in the fridge and freezer doors and install them at the left of the doors.
Take down CAP HOLE DOOR and CAP SPACER DOOR and fix them at the left of the doors,
6. Fix MID HINGE with SCREW A and SCREW E, and install the freezer door Fix HINGE-LOW to the left and install FOOT.
Put the refrigerator stable and install the fridge door.
Fix HINGE UPP with SCREW A.

VIEW OF YOUR FRIDGE / FREEZER (RL40E*,RL40H*,RL40S*,RL40Z*,RL40L*,RL40U*)

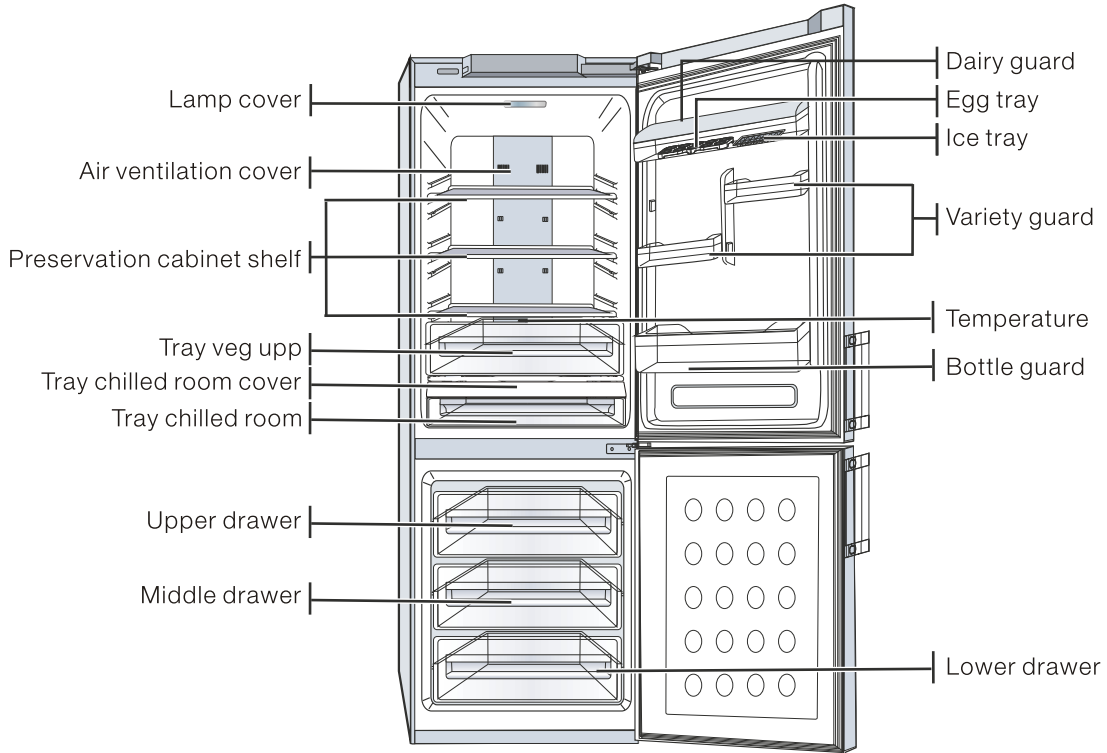

INTERIOR ACCESSORIES	Preservation cabinet shelf	3
	Tray chilled room cover	1
	Tray veg up(only RL40Z*/RL40U*)	1
	Tray chilled room	1
	upper drawer	1
	middle drawer	1
DOOR SET ACCESSORIES	lower drawer	1
	Dairy guard	1
	Variety guard	4
	Bottle guard	1
	Egg tray	1
	Ice tray	1

VIEW OF YOUR FRIDGE / FREEZER(RL40W*)

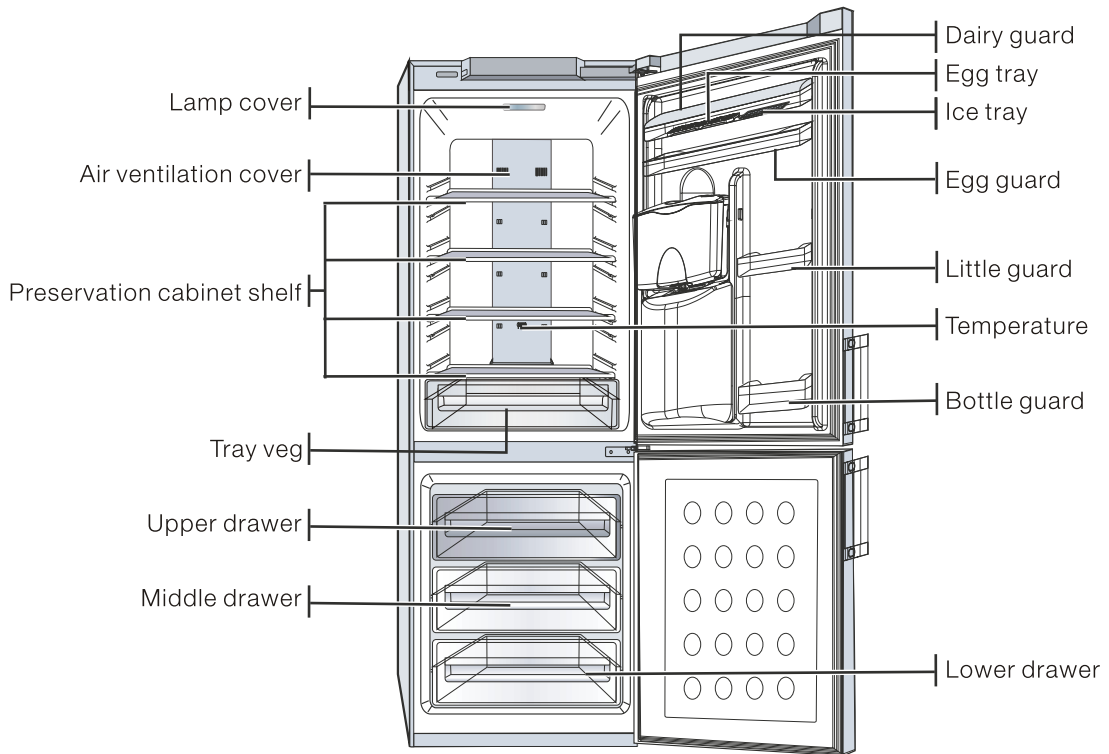

INTERIOR ACCESSORIES	Preservation cabinet shelf	4
	Tray veg	1
	upper drawer	1
	middle drawer	1
	lower drawer	1
DOOR SET ACCESSORIES	Dairy guard	1
	Egg guard	1
	Little guard	2
	Bottle guard	1
	Egg tray	1
	Ice tray	1

VIEW OF YOUR FRIDGE / FREEZER (RL34E*, RL34S*, RL34H*, RL37H*, RL34L*, RL37L*)

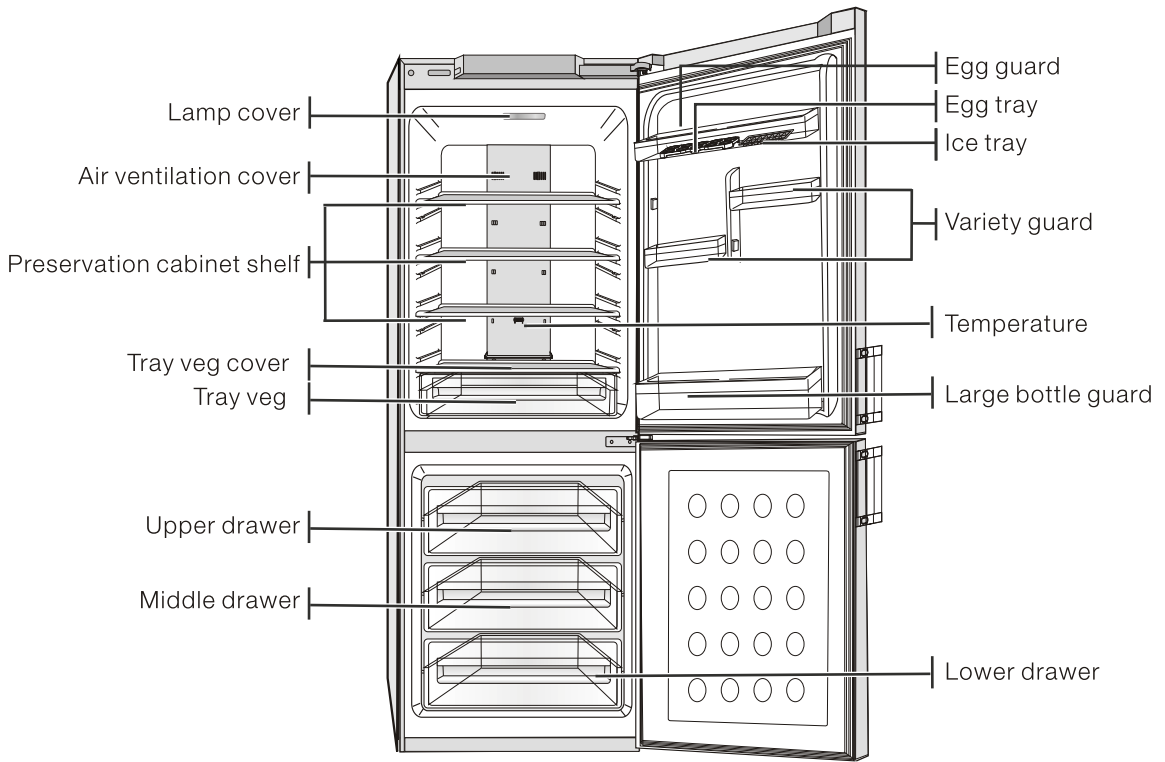

INTERIOR ACCESSORIES	Preservation cabinet shelf	3
	Tray veg cover	1
	Tray veg	1
	upper drawer	1
	middle drawer	1
	lower drawer	1
DOOR SET ACCESSORIES	Egg guard	1
	Variety guard	2
	Large bottle guard	1
	Egg tray	1
	Ice tray	1

Troubleshooting

PROBLEM	SOLUTION
The appliance is not operating at all or the temperature is too high	<ul style="list-style-type: none"> • Check that the power plug is correctly connected. • Is the temperature control on the front panel correctly set? • Does sun shine on the appliance or are there heat sources nearby? • Is the back of the appliance too near to the wall?
The food in the refrigerator is frozen	<ul style="list-style-type: none"> • Is the temperature control on the front panel set to the coldest temperature? • Is the surrounding temperature too low? • Did you put the hot food in the refrigerator?
There are unusual noises	<ul style="list-style-type: none"> • Check that the appliance is installed on a stable, level floor. • Is the back of the appliance too near to the wall? • Have any foreign objects fallen behind or under the appliance? • Is there noise coming from the compressor in the appliance? • A ticking sound may be heard inside the appliance; this is normal. • This sound occurs when the various accessories contract or expand.
The front corners and sides of the appliance are warm and condensation starts to form	<ul style="list-style-type: none"> • Heat-proof pipes are installed in the front corners of the appliance to prevent condensation from forming. When the surrounding temperature rises, this may not always be effective. However, this is not abnormal. • In very humid weather, condensation may form on the outer surface of the appliance when the moisture in the air comes into contact with the cool surface of the appliance.
You can hear a liquid babbling in the appliance	<ul style="list-style-type: none"> • This is the refrigerant, which cools the inside of the appliance.
There is a bad smell inside the appliance	<ul style="list-style-type: none"> • You did not seal the food. • Check food are covered and ensure the cold inlet is clean.
There is a layer of frost on the appliance's walls	<ul style="list-style-type: none"> • Is the air outlet on the appliance plugged up? • Space the food out as much as possible to improve ventilation. • Is the door fully closed?
If condensation forms on the inside wall of the appliance and around vegetables	<ul style="list-style-type: none"> • Can occur if food with a high water content is stored uncovered with a high humidity level or the door has been left open for a-long time. • Store the food with a cover or in sealed containers. <p style="text-align: center;">Power Saving Tips</p> <ul style="list-style-type: none"> • Install the appliance in a cool, dry room with adequate ventilation. Ensure that it is not exposed to direct sunlight and never put it near a direct source of heat (radiator, for example). • Never block any vents or grilles on the appliance. • Allow warm food to cool down before placing it in the appliance. • Put frozen food in the refrigerator to thaw. You can then use the low temperatures of the frozen products to cool food in the refrigerator. • Do not keep the door of the appliance open for too long when putting food in or taking food out. The shorter time for which the door is open, the less ice will form in the freezer. • Allow clearance to the right, left, back and top when installing. This will help reduce power consumption and keep your energy bills lower.

Ambient room temperature limits

This fridge/freezer is designed to operate in ambient temperatures specified by its temperature class marked on the rating plate.

Temperature Class	Symbol	Ambient Temperature	
		Maximum	Minimum
Extended Temperate	SN	32°C (90F)	10°C (50F)
Temperate	N	32°C (90F)	16°C (61F)
Subtropical	ST	38°C (100F)	18°C (64F)



Internal temperatures may be affected by such factors as the location of the fridge/freezer, ambient temperature and the frequency with which you open the-door. Adjust the temperature as required to compensate for these factors.

English

Correct Disposal of This Product (Waste Electrical & Electronic Equipment) (Applicable in the European Union and other European countries with separate collection systems)

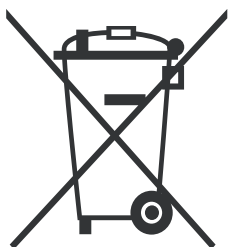

This marking shown on the product or its literature, indicates that it should not be disposed with other household wastes at the end of its working life. To prevent possible harm to the environment or human health from uncontrolled waste disposal, please separate this from other types of wastes and recycle it responsibly to promote the sustainable reuse of material resources.

Household users should contact either the retailer where they purchased this product, or their local government office, for details of where and how they can take this item for environmentally safe recycling.

Business users should contact their supplier and check the terms and conditions of the purchase contract. This product should not be mixed with other commercial wastes for disposal.

MEMO



Question or Comments?

COUNTRY	CALL	OR VISIT US ONLINE AT
CANADA	1 -800-SAMSUNG (7267864)	www.samsung.com/ca
MEXICO	01 -800-SAMSUNG (7267864)	www.samsung.com/mx
U.S.A	1-800-SAMSUNG(726-7864)	www.samsung.com/us
AUSTRIA	0810-SAMSUNG(7267864, €0.07/min)	www.samsung.com/at
ARGENTINE	0800-333-3733	www.samsung.com/ar
BRAZIL	0800-124-421/4004-0000	www.samsung.com/br
CHILE	800-SAMSUNG(726-7864)	www.samsung.com/cl
COSTA RICA	0-800-507-7267	www.samsung.com/latin
COLOMBIA	01-8000112112	www.samsung.com.co
EL SALVADOR	800-6225	www.samsung.com/latin
GUATEMALA	1-800-299-0013	www.samsung.com/latin
JAMAICA	1-800-234-7267	www.samsung.com/latin
PANAMA	800-7267	www.samsung.com/latin
PUERTO RICO	1-800-682-3180	www.samsung.com/latin
REP. DOMINICA	1-800-751-2676	www.samsung.com/latin
TRINIDAD & TOBAGO	1-800-SAMSUNG(726-7864)	www.samsung.com/latin
VENEZUELA	1-800-100-5303	www.samsung.com/latin
ECUADOR	1-800-10-7267	www.samsung.com/latin
BELGIUM	02 201 2418	www.samsung.com/be
CZECH REPUBUC	800 - SAMSUNG (800-726786)	www.samsung.com/cz
DENMARK	70 70 19 70	www.samsung.com/dk
FINLAND	030 - 6227 515	www.samsung.com/fi
FRANCE	01 4863 0000	www.samsung.com/fr
GERMANY	01805 - SAMSUNG(7267864, €0.14/Min)	www.samsung.de
HUNGARY	06-80-SAMSUNG(7267864)	www.samsung.com/hu
ITALIA	800-SAMSUNG(7267864)	www.samsung.com/it
LUXEMBOURG	261 03 710	www.samsung.com/lu
NETHERLANDS	0900 - SAMSUNG(7267864, € 0.10/Min)	www.samsung.com/nl
NORWAY	815-56 480	www.samsung.com/no
POLAND	0-801- 1SAMSUNG (172678)/022 - 607 -93-33	www.samsung.com/pl
PORTUGAL	808 20 - SAMSUNG(7267864)	www.samsung.com/pt
SLOVAKIA	0800 - SAMSUNG(7267864)	www.samsung.com/sk
SPAIN	902 - 1 - SAMSUNG (902 172 678)	www.samsung.com/es
INDIA	33030 8282/1800-29-3232/02-689-3232 /1800 266 8282	www.samsung.com/in
AUSTRALIA	1300 362 603	www.samsung.com/au
SWEDEN	0771 726 7864 (SAMSUNG)	www.samsung.com/se
U.K	0845 SAMSUNG(7267864)	www.samsung.com/uk
EIRE	0818 717 100	www.samsung.com/ie
SWITZERLAND	0848 - SAMSUNG(7267864, CHF0.08/min)	www.samsung.com/ch
RUSSIA	8-800-555-55-55	www.samsung.ru
UKRAINE	0-800-502-000	www.samsung.ua www.samsung.com/ua_ru
INDONESIA	0800-112-8888/021-5699-7777	www.samsung.com/id
MALAYSIA	1800-88-9999	www.samsung.com/my
PHILIPPINES	1800-10-SAMSUNG (7267864)	www.samsung.com/ph
SINGAPORE	1800-SAMSUNG (7267864)	www.samsung.com/sg
VIETNAM	1 800 588 889	www.samsung.com/vn
THAILAND	1800-29-3232/02-689-3232	www.samsung.com/th
SOUTH AFRICA	0860 726 7864 (SAMSUNG)	www.samsung.com/za
U.A.E	800-SAMSUNG (726-7864)/8000-4726	www.samsung.com/ae