

1. Freezer

Freezer

Exploded View

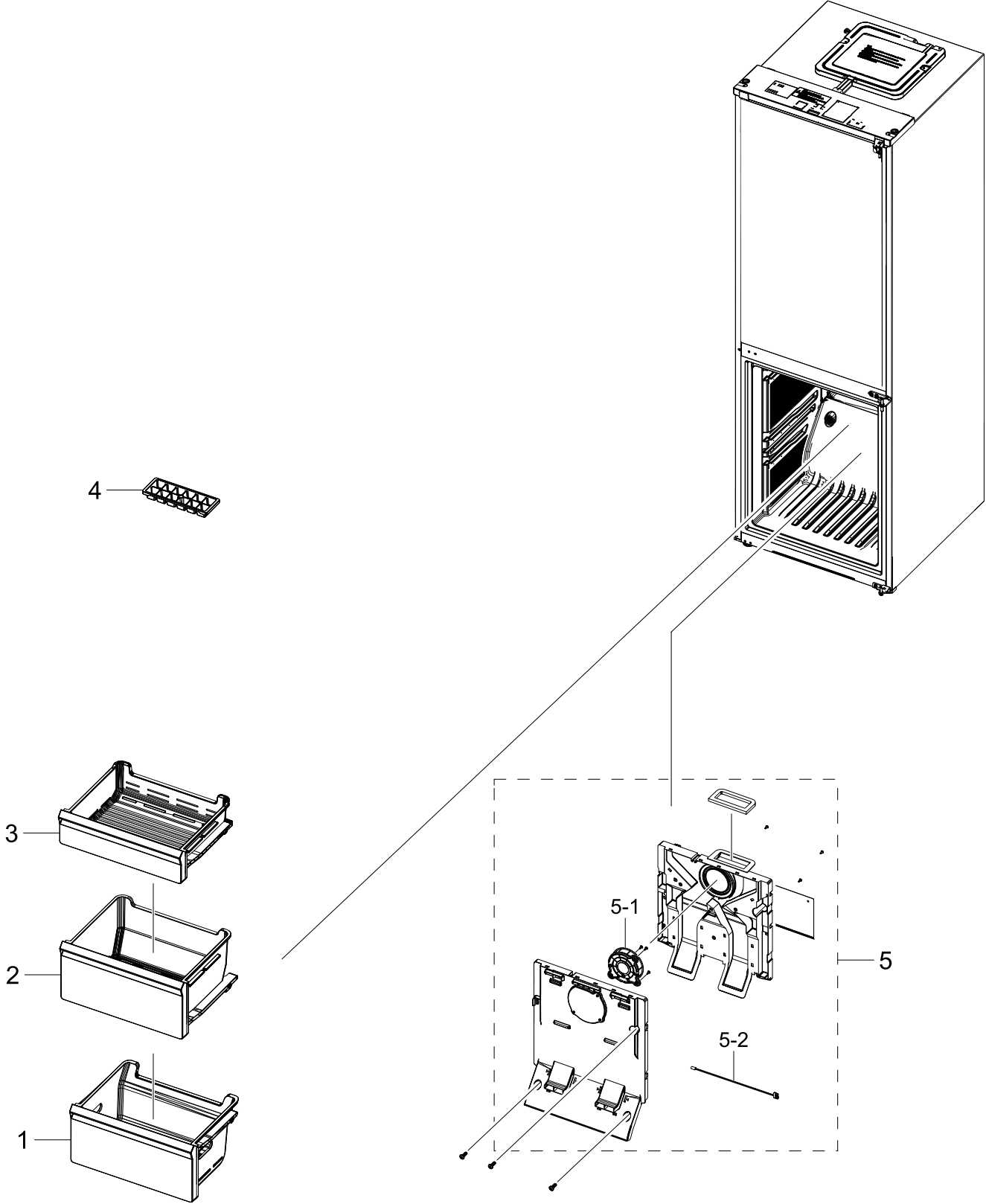

Parts List

No.	Lvl.	Loc.	Material Code	Description & Specification	SNA	Qty.
1	2	G0267	DA97-21136A	ASSY TRAY-FRE LOW DRAWER MODULE; RB7300T,	SA	1
2	2		DA97-21135A	ASSY TRAY-FRE MIDDLE DRAWER MODULE; RB730	SA	1
3	2	M0483	DA97-21134A	ASSY TRAY-FRE UP DRAWER MODULE; RB7300T,T	SA	1
4	2	A0120	DA67-40146B	TRAY ICE-ICE MODULE; SR-1500,PP,HB,COOL W	SA	1
5	2	M0303	DA97-21145A	ASSY COVER EVAP-FRE COVER EVAP MODULE; RB	SA	1
5-1	3		DA31-00334C	MOTOR BLDC FAN;12035GE-12M-YT,1775±7%,12	SA	1
5-2	3	A1018	DA32-10105X	SENSOR TEMP;QUEEN PJT,-40~120°C,5V,F-SENS	SA	1

2. Fridge

Fridge

Exploded View

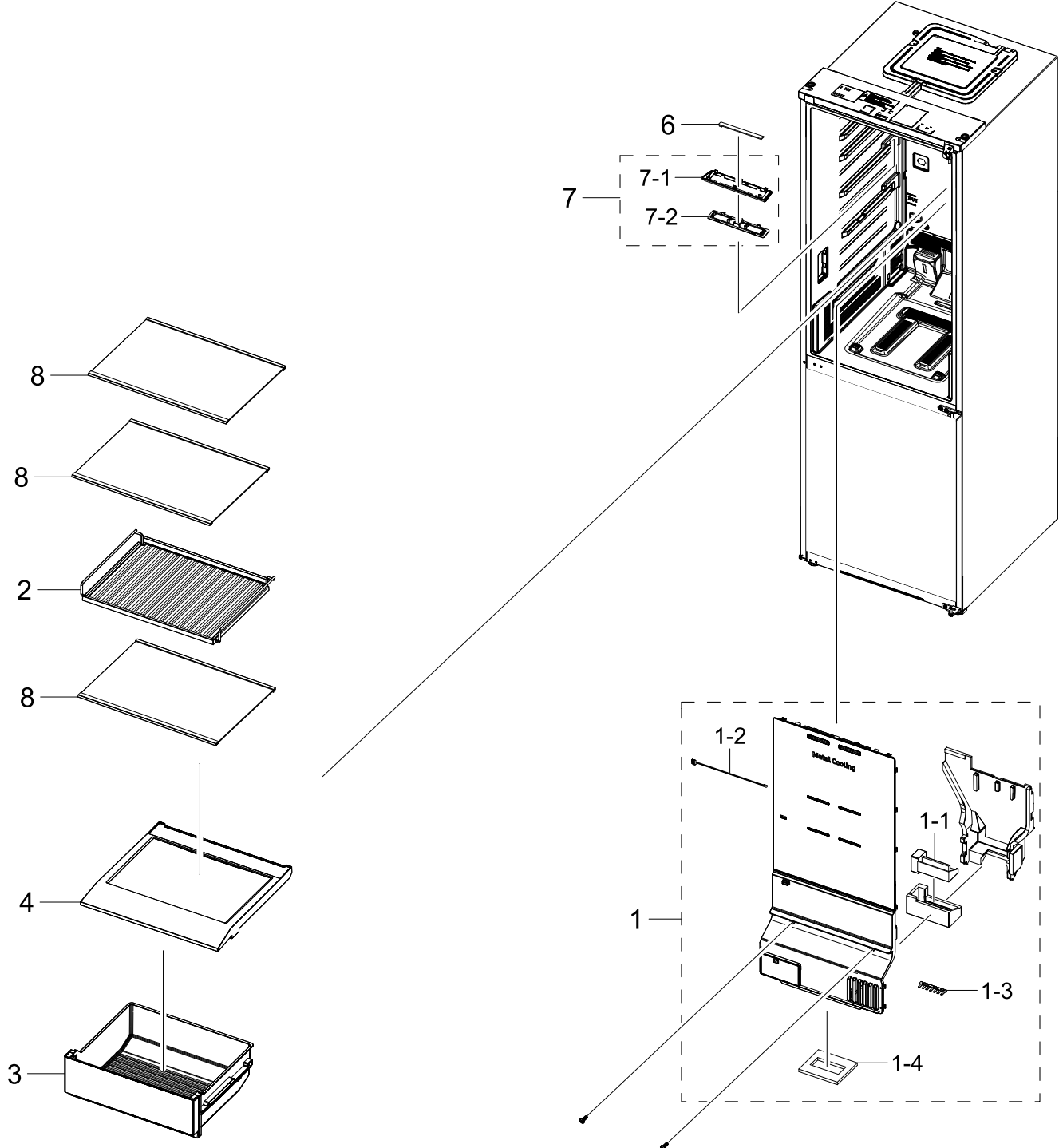

Parts List

No.	Lvl.	Loc.	Material Code	Description & Specification	SNA	Qty.
1	2	G0239	DA97-21142C	ASSY COVER MULTI-REF MULTI MODULE; RB7300	SA	1
1-1	3		DA31-00333C	MOTOR GEARED DC DAMPER; NSBA001TN1,12V,60	SA	1
1-2	3	A1018	DA32-00070D	SENSOR TEMP; SC41199-021A,L900,13.2kohm,2	SA	1
1-3	3		DA61-11032A	FIXER; RT5000K,PA66,WHITE,KN3322V0,7P Ret	SA	1
1-4	3		DA62-05494A	SEAL INS MULTI-REF LOW; RB7300T,PE OPEN C	SA	1
2	2		DA97-21091A	ASSY SHELF WIRE-SHELF MODULE; RB7300T,WIN	SA	1
3	2	M0300	DA97-21133C	ASSY CASE VEG-LOW DRAWER MODULE; RB7300T,	SA	1
4	2		DA97-21138A	ASSY SHELF-VEG LOW SHELF MODULE; RB7300T	SA	1
6	2		DA96-01119A	ASSY LAMP LED; 3EA,FR-4,150*12,WHITE,SMAW	SA	1
7	2		DA97-21569A	ASSY COVER LAMP; RB7300T,COVER LAMP, ASSY	SA	1
7-1	3	A0190	DA61-14156A	CASE LAMP; RB7300T,HIPS,T2,COOL WHITE,S83	SA	1
7-2	3	A0280	DA63-09898A	COVER LAMP; RB7300T,GPPS,T2,HB,TP BLUE,14	SA	1
8	2		DA97-13502D	ASSY SHELF-GLASS REF SHELF MODULE; RL31/2	SA	3

3. Cabinet1

Cabinet1

Exploded View

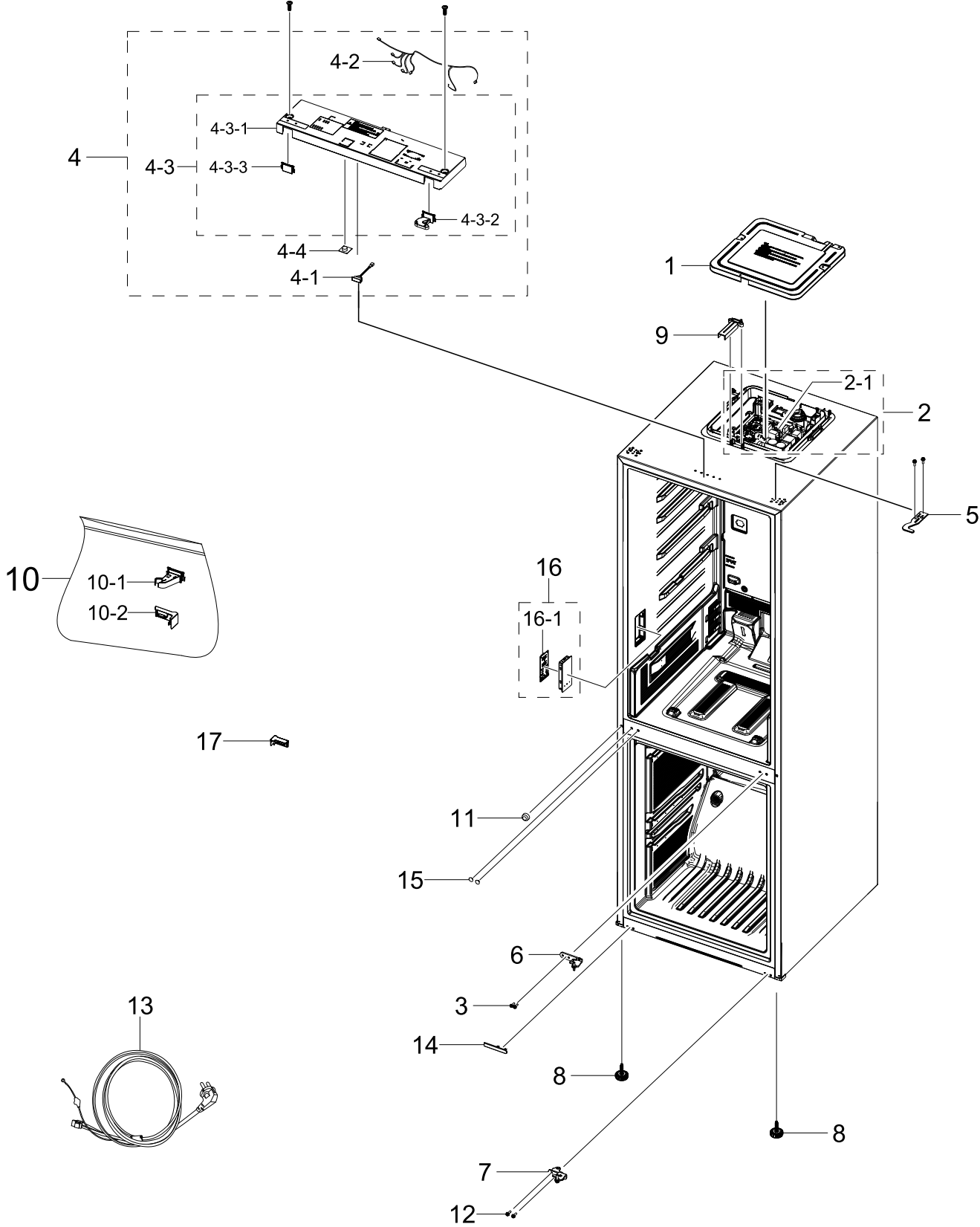

Parts List

No.	Lvl.	Loc.	Material Code	Description & Specification	SNA	Qty.
1	2		DA97-21372A	ASSY COVER PBA-MAIN; RB7300T,GI-SGCC,T0.4	SA	1
2	1		DA94-05956U	ASSY PCB EEPROM; 0x37,DA92-01296E,D602,D6	SA	1
2-1	2	A0952	DA92-01296E	ASSY PCB MAIN; MONO COOLING,RB7300T,160*1	SNA	1
3	2	A0564	DA60-10123C	BOLT-HEX; M6,L24,ZPC(WHT),SWRCH18A,HWH He	SA	2
4	2	A1288	DA97-21246Q	ASSY TOP TABLE; RB7300,GRAY,BESPOKE,MONO	SA	1
4-1	3		DA34-00043J	SWITCH REED; UL1007 AWG 22,50mm	SA	1
4-2	3		DA96-01418B	ASSY WIRE HARNESS-TOP; RB7300T, Mono,INTE	SA	1
4-3	3		DA97-22073E	ASSY TOP TABLE-FRONT; RB7300T,BESPOKE,DAR	SA	1
4-3-1	4	A1109	DA64-06305A	TOP TABLE; RB7300T,ABS,INOX GRAY	SA	1
4-3-2	4		DA63-11283A	COVER WIRE-HINGE RIGHT; RB7300 TWIN,ABS,T	SA	1
4-3-3	4		DA67-05048A	CAP HINGE; RB7300T,ABS,T2,HB,HG-0760GP,IN	SA	1
4-4	3		DA92-00817A	ASSY MODULE; BUZZER PBA,RB6000K	SA	1
5	2		DA97-22034A	ASSY HINGE-UP; RB7300T(B),T4,BESPOKE	SA	1
6	2		DA97-22223A	ASSY HINGE-MIDDLE; RB7300 Bespoke,T4.5,BL	SA	1
7	2	M0344	DA97-22250A	ASSY HINGE-LOW; RB7300T,T4,BLACK,BESPOKE	SA	1
8	2	Z1128	DA61-07546B	LEG-FRONT; GRAND CRU,PP,BLACK,RM60,PP Scr	SA	2
9	2		DA63-09844A	COVER WIRE-CABI; RB7300T,ABS,T2,HB,INOX G	SA	1
10	2		DA91-05606D	ASSY INSTALL-ACCESSORY; RB7300T(B),DARK G	SA	1
10-1	3		DA63-11284A	COVER WIRE-HINGE LEFT; RB7300 TWIN,ABS,T1	SA	1
10-2	3		DA67-05191A	CAP SPACE-DOOR RIGHT; RB7300T(B),ABS,HG-0	SA	1
11	2		DA67-03725A	CAP SCREW; 3050,PP,HB,49MK45,INOX GRAY	SA	1
12	2	A0564	6011-001546	BOLT-HEX; M5(P0.8),L16,ZPC(WHT),HWH,+,SWR	SA	2
13	2	A0273	3903-001024	POWER CORD-AT; H05VV-F 3x0.75mm2,BLK,GB3F	SA	1
14	2		DA67-05095A	CAP SCREW-A; RB7300T,ABS,T1.5,GP-35,COOL	SA	1

No.	Lvl.	Loc.	Material Code	Description & Specification	SNA	Qty.
15	2		DA67-04049A	CAP HINGE-HOLE; BK,ABS,T2,HB,GP-35,SNOW W	SA	2
16	2	A0626	DA97-21005Q	ASSY COVER CONTROL; RB7300T,TWIN	SA	1
16-1	3		DA92-01298C	ASSY PBA MODULE-DISPLAY; LED DISPLAY,RF50	SNA	1
17	2		DA67-05190A	CAP SPACE-DOOR LEFT; RB7300T(B),ABS,HG-07	SA	1

4. Cycle

Cycle

Exploded View

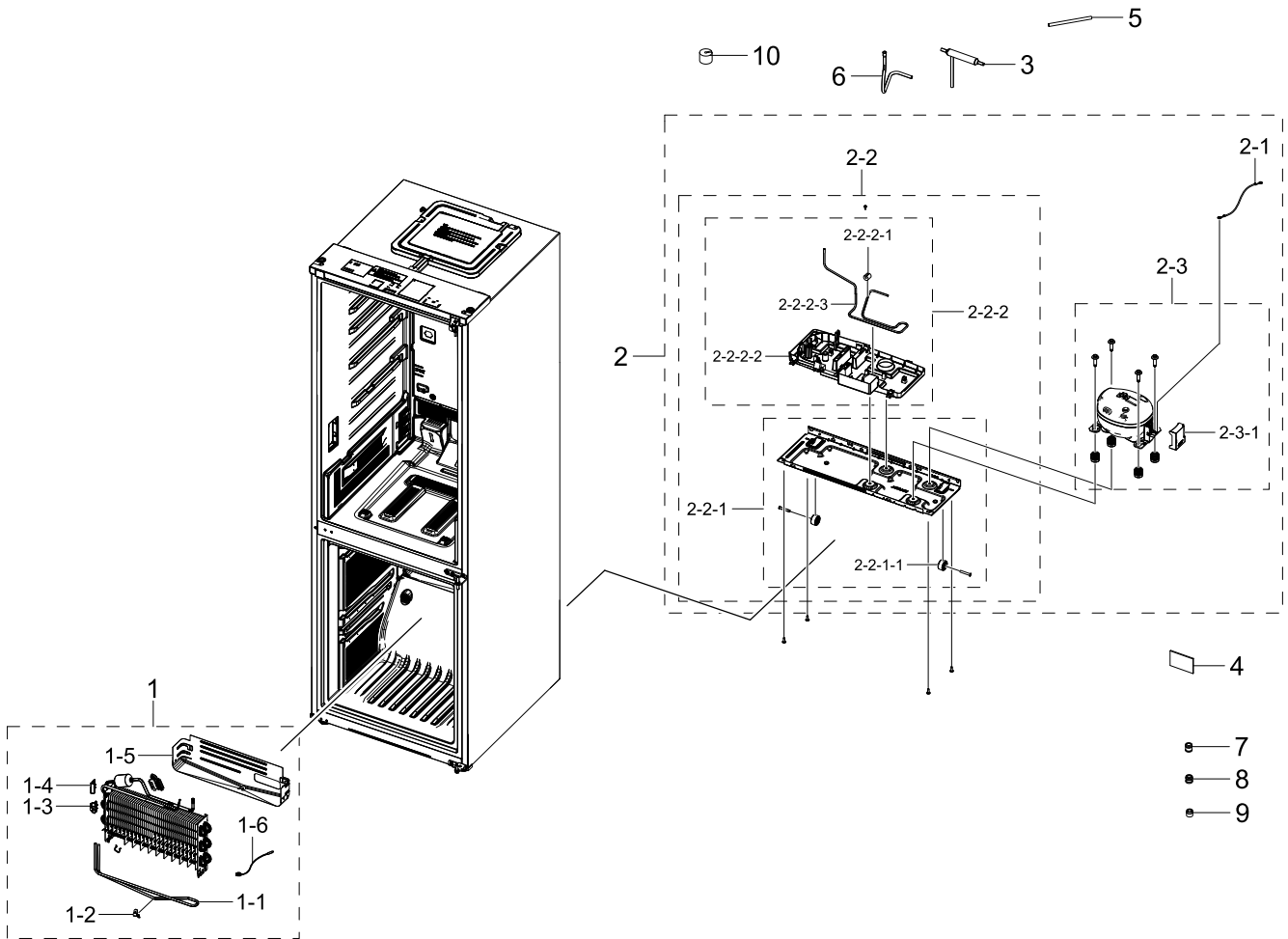

Parts List

No.	Lvl.	Loc.	Material Code	Description & Specification	SNA	Qty.
1	2	A0163	DA96-01009F	ASSY EVAP-FRE EVAP MODULE; RB7300, 3050,2	SA	1
1-1	3		DA47-00507E	HEATER METAL SHEATH; AC230V,377.9ohm,140W	SNA	1
1-2	3	M9010	DA61-03644A	PLATE-EVAP HEATER; AW-PJT,Al,T0.7	SA	1
1-3	3	G0205	DA61-04921B	FIXER-HEATER FRE; HERMES-PJT,PP,NATURAL,F	SA	1
1-4	3	A0744	DA61-07411A	FIXER-FUSE; NW2,PP,NATURAL,BJ750	SA	1
1-5	3	A0754	DA61-08936A	PLATE-DRAIN; 3050,GI-SGCC,T0.3	SA	1
1-6	3	A1018	DA32-00006D	SENSOR TEMP; F DEF-SENSOR,L250,200kohm,1%	SNA	1

No.	Lvl.	Loc.	Material Code	Description & Specification	SNA	Qty.
2	2		DA97-21454F	ASSY COMP N CONDENSING; RB7300(B),E GRADE	SNA	1
2-1	3	A0562	DA39-20389A	ASSY WIRE HARNESS-EARTH; EARTH,ALL,FREE V	SA	1
2-2	3		DA97-21380A	ASSY CHASSIS; RB7300T,PIPE IMMERSING	SNA	1
2-2-1	4	A0526	DA97-21174A	ASSY CHASSIS COMP; RB7300T,GI-SGCC,T0.8,C	SA	1
2-2-1-1	5	A0527	DA61-06202A	CASTER-REAR; GRAND-CRU,PP,NATURAL	SA	2
2-2-2	4	A0529	DA97-21176A	ASSY TRAY DRAIN WATER; RB7300T,No fan, No	SNA	1
2-2-2-1	5	M0333	DA63-40171B	GROMMET-SUCT PIPE A; NBR,ID4,OD20	SC	1
2-2-2-2	5		DA97-21381A	ASSY TRAY DRAIN WATER-SUB; RB7300T	SA	1
2-2-2-3	5		DA62-05493A	PIPE IMMERSING-IN; RB7300T,TSW,OD4.76,T0.	SA	1
2-3	3		NI34T9101ADAKC	CMP,COMP,REFRIGERATOR,R600A; CMP,COMP,REFRIGERATOR,R600A		1
2-3-1	4	Z1032	DA63-09465A	COVER RELAY; S3,PC,T2,5VB,BLACK,EF1006F	SA	1
3	2	A0669	DA62-04309C	DRYER; C1220T-H,L118,SINGLE MOUTH,For Cap	SA	1
4	2		DA72-60040W	SEAL-CUTT RUBBER; TD-PJT,RUBBER,T5,W35,L3	SA	1
5	2	A0523	DA73-10190U	PIPE-CONNECT DISC,B; ALL,Cu,C1220T,OD6.35	SA	1
6	2		DA62-05500A	PIPE CONNECT-SUCTION; RB7300T,Cu,OD6.35,T	SA	1
7	2		DA60-00279A	FITTING-LOKRING 16; SUM23,16, 11SMnPb30K	SA	1
8	2		DA60-00280A	FITTING-LOKRING 33; SUM23,ID3/16,33, 11SM	SA	1
9	2		DA60-00281A	FITTING LOCK SLEEVE; SUM23,ID5.02,11SMnPb	SA	1
10	2	M0334	DA63-40171D	GROMMET-SUCT PIPE B; RAIL L20,NBR,ID5.5,O	SA	1

5. Assy Door

Assy Door

Exploded View

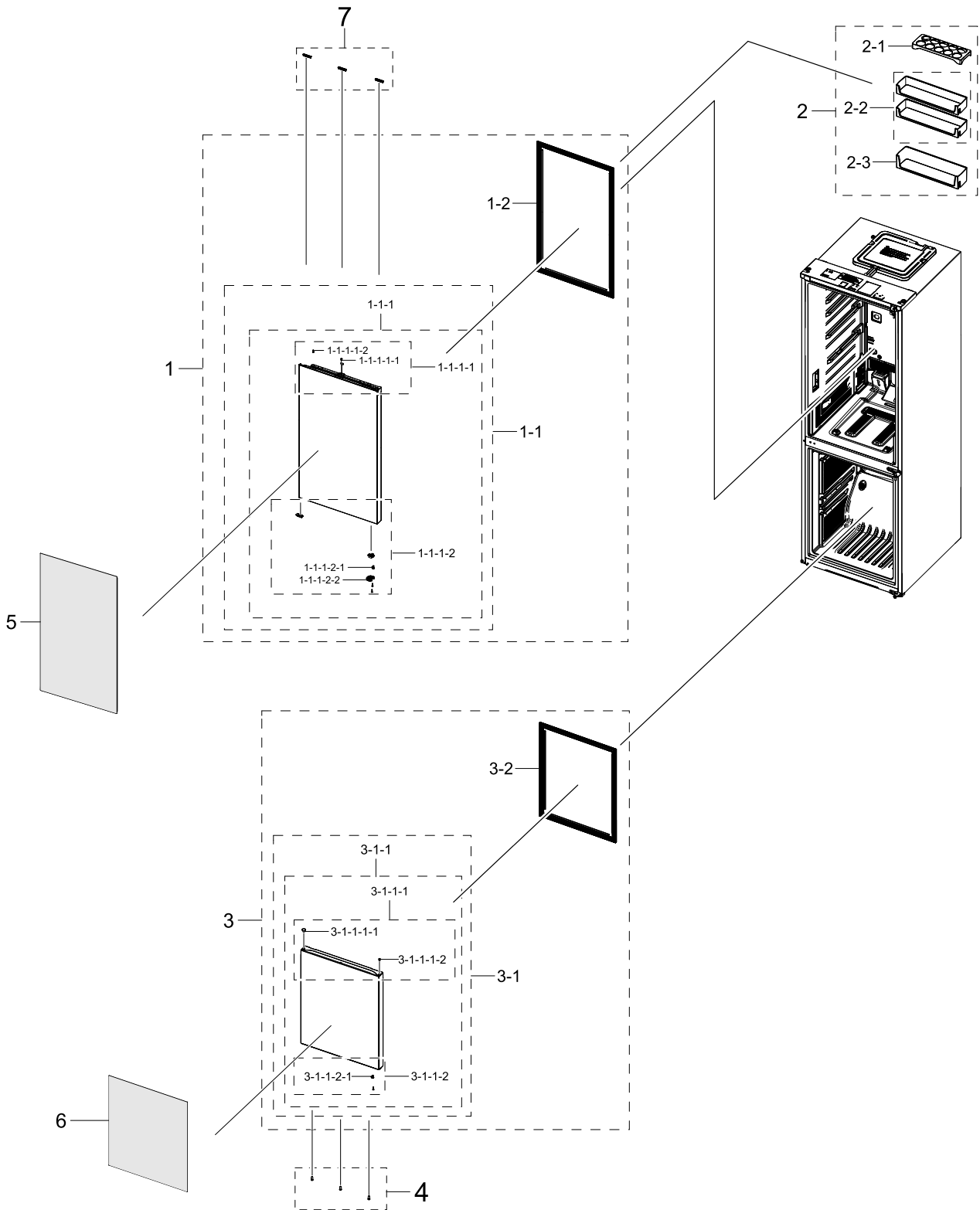

Parts List

No.	Lvl.	Loc.	Material Code	Description & Specification	SNA	Qty.
1	2		DA93-00951E	ASSY DOOR SUB-REF DOOR MODULE; RB7300T(B)	SNA	1
1-1	3	Z1100	DA91-05496E	ASSY DOOR FOAM-REF; RB7300T(B),AP(PANEL R	SA	1
1-1-1	4		DA97-22077A	ASSY PLATE DOOR-REF; RB7300T(B),RB34	SNA	1
1-1-1-1	5		DA97-22079A	ASSY CAP DOOR-REF UP; RB7300T(B),ABS,DARK	SNA	1
1-1-1-1-1	6		DA67-02795C	CAP-SHAFT HOLE; AW3,ABS,HG-0760GP,SNOW WH	SA	1
1-1-1-1-2	6		DA63-07545A	GROMMET HINGE-MIDDLE; FOOD SHOWCASE,PA66,	SA	1
1-1-1-2	5	A0048	DA97-22080A	ASSY CAP DOOR-REF LOW; RB7300T(B),ABS,DAR	SNA	1
1-1-1-2-1	6		DA63-09976A	GROMMET DOOR-REF; RB7300T,POM,BLACK	SA	1
1-1-1-2-2	6		DA66-01517A	LEVER AUTO CLOSE; RB7300T(B),POM,K300,BLA	SA	1
1-2	3		DA97-21243E	ASSY GASKET; RB7300,DARK GRAY,Sub Combina	SA	1
2	1	A0166	DA90-12422D	ASSY GUARD; RB7300T,RB34,TP Blue,REF UP(2	SNA	1
2-1	2	A0656	DA63-06221A	TRAY EGG; RF9000A,GPPS,T2.5,TP BLUE	SA	1
2-2	2	M0447	DA63-09799A	GUARD-REF UP DOOR BIN MODULE; RB7300T,GPP	SA	2
2-3	2	A0151	DA63-09802A	GUARD-BOTTLE DOOR BIN MODULE; RB7300T,GPP	SA	1
3	2		DA93-00950G	ASSY DOOR SUB-FRE DOOR MODULE; RB7300T(B)	SNA	1
3-1	3	M0063	DA91-05497G	ASSY DOOR FOAM-FRE; RB7300T(B),AP(PANEL R	SA	1
3-1-1	4		DA97-22078A	ASSY PLATE DOOR-FRE; RB7300T(B)	SNA	1
3-1-1-1	5		DA97-22081A	ASSY CAP DOOR-FRE UP; RB7300T(B),ABS,DARK	SNA	1
3-1-1-1-1	6		DA67-04054H	CAP HINGE; RB7300T,ABS,T1.6,HB,HG-0760GP,	SA	1
3-1-1-1-2	6	A0827	DA63-08059A	GROMMET HINGE; BK65,60,PA66,BLACK	SA	1
3-1-1-2	5	A0047	DA97-22082A	ASSY CAP DOOR-FRE LOW; RB7300T(B),ABS,BLA	SNA	1
3-1-1-2-1	6		DA63-09976A	GROMMET DOOR-REF; RB7300T,POM,BLACK	SA	1
3-2	3		DA97-21244A	ASSY GASKET-FRE; RB7300T,DARK GRAY,Sub Co	SA	1
4	2		DA67-04961A	CAP SCREW; RQ9500(B),ABS+PET,EG-7030,DARK	SA	3
5	2		DA99-04503B	ASSY ACCESSORY-CUSTOM PANEL; RB7300T,B-PJ	SA	1

Exploded Views and Parts List

No.	Lvl.	Loc.	Material Code	Description & Specification	SNA	Qty.
6	2		DA99-04503C	ASSY ACCESSORY-CUSTOM PANEL; RB7300T,B-PJ	SA	1
7	2		DA63-09686A	COVER CAP DOOR; ABS,T1.5,DARK GRAY,RM-076	SA	3